

# MINDEO

## CS3290 Cordless Barcode Scanner

### User Manual



Version: CS3290\_UM\_EN\_V1.2.16

## Notice

Make sure you carefully read the following information to ensure that your barcode scanner is able to perform at the level for which it is designed.

1. All software, including firmware, furnished to the user is on a licensed basis.
2. The right is reserved to make changes to any software or product to improve reliability, function, or design.
3. The material in this manual is subject to change without notice.
4. The manufacturer assumes no responsibility for any loss or claims by third parties which may arise from the use of this manual.
5. A standard kit contains: a handheld unit, a cradle, a USB cable, an antenna, and a CD-ROM (containing software and electrical manuals).
6. Do not throw or drop the scanner or otherwise subject it to strong impact, which can damage the scanner, interrupt program execution, corrupt memory contents, or otherwise interfere with proper operation.
7. Use a blunt object to operate the stroke keys. Use of a sharp pointed object can damage stroke keys and cause shorting of internal circuitry.
8. Never try to remove the battery from the scanner.
9. Sudden temperature changes can cause condensation to form on the scanner's case. Operating the scanner while condensation is present can interfere with proper operation. Take care to avoid conditions that cause the formation of condensation. If condensation does form, wait until it dries completely before using the scanner.
10. The scanner offers two kinds of wireless network topology: point coordination and distributed coordination. The default setting of wireless network topology is point coordination. To change the wireless network topology, you must change the setting of both handheld unit and cradle.
11. The scanners within same working area must apply the same wireless network topology.
12. When the point coordination wireless network topology is used, if multi-clusters are working in the same area, then each cluster must use a different radio frequency channel. Both of the handheld unit and cradle must be configured individually.
13. When the distributed coordination wireless network topology is used, if multi-clusters are working in the same area, it is strongly recommended that different radio frequency channel numbers are applied to different clusters. While setting up, only the radio frequency channel number of the first handheld unit of a single cluster is required to be set. When the first handheld unit binds to the cradle, the cradle will automatically obtain the radio frequency channel number of the handheld unit. The consecutive joined handheld units will automatically obtain the radio frequency channel number of the cradle.
14. In order to obtain constantly good communication quality, when in multi-clusters working mode, the physical space between two cradles is required to be at least 2 meters.
15. In order to obtain constantly good communication quality, it is recommended to place the cradle on a higher location, generally more than 1 meter above the ground. If working outdoor, the higher

location the better.

## Safety precautions – Danger!

Be sure to read the following safety precautions carefully before trying to use the barcode scanner for the first time. Keep this manual in handy place for future reference.



### **Danger!**

This symbol indicates information that, if ignored or applied incorrectly, creates the danger of death or serious personal injury.

---

#### **Lithium-ion battery**

- 1) Never allow the battery to become wet. Water can create the danger of battery heat emission, explosion, and fire.
- 2) Never use or leave the battery next to open flame, near a stove, or any other area exposed to high heat. Doing so creates the danger of battery heat emission, explosion, and fire.
- 3) Never use the battery with any device other than this unit. Doing so can create the danger of battery heat emission, explosion, and fire.
- 4) Note that the battery's positive (+) and negative (-) terminals must be oriented correctly when it is loaded into the Barcode Scanner. Connecting the battery with its terminals reversed creates the danger of battery fluid leakage, heat emission, explosion, and fire.
- 5) Never dispose of the battery by incinerating it or otherwise expose it to heat. Doing so creates the danger of battery heat emission, explosion, and fire.
- 6) Never allow the positive (+) and negative (-) terminals of the battery to become connected (shorted) by metal. Doing so creates the danger of battery heat emission, explosion, and fire.
- 7) Never transport or store the battery together with a necklace, hair pins or other metal objects. Doing so can short battery terminals, and create the danger of battery heat emission, explosion and fire. Be sure to place the battery in its case whenever transporting or storing it.
- 8) Never throw the battery or otherwise subject it to strong impact. Doing so creates the danger of battery heat emission, explosion, and fire.
- 9) Never pierce the battery with nails, hit it with a hammer, or step on it. Doing so can create the danger of battery heat emission, explosion, and fire.
- 10) Never try to take apart the battery in any way. Doing so creates the danger of battery heat emission, explosion, and fire.
- 11) Use only the specified charger to charge the battery. Use of other types of charger creates the danger of battery heat emission, explosion, and fire.

## Safety precautions – Warning!



### Warning!

This symbol indicates information that, if ignored or applied incorrectly, can create the possibility of death or serious personal injury.

---

#### **Disassembly and modification**

Never try to disassemble or modify the unit in any way. High voltage inside creates the danger of electrical shock.

#### **Interior parts and components**

Never touch interior high-voltage parts or components. Doing so creates the danger of electrical shock.

#### **Abnormal conditions**

Should the unit become hot or start to emit smoke or a strange odor, immediately turn off the power and contact your original dealer. Continued use creates the danger of fire and electrical shock.

#### **Foreign objects**

Should any foreign matter ever get into the unit, immediately turn off the power and contact your original dealer. Continued use creates the danger of fire and electrical shock.

#### **Dropping and damage**

Should you drop the unit and damage it, immediately turn off the power and contact your original dealer. Continued use creates the danger of fire and electrical shock.

#### **Laser beam**

Never look directly into the laser beam. Doing so can cause serious eye damage.

#### **Lithium-ion battery**

- 1) Do not put a battery in microwave ovens or pressure cookers. Doing so may cause the battery to overheat, explode or burst into flames.
- 2) Do not use a battery that smells strange, is overheating, is a strange color, or is a strange shape. Doing so may cause the battery to overheat, explode or burst into flames.
- 3) If the amount of time period the battery can serve becomes considerably short, stop using it. It may indicate the possibility of a malfunction in the battery. Continued charging the battery creates the danger of heat emission, explosion, and fire.
- 4) Stop charging the battery after the recommended time even if it is not fully charged. Continuing to charge the battery may cause the battery to over heat, explode or burst into flames.
- 5) If the battery leaks fluid or emits a strange smell, remove it from near heat or flames. Burning may cause the battery to explode or burst into flames.
- 6) Should fluid from the battery accidentally get into your eyes, do not rub them. Immediately rinse your eyes with clean water such as tap water and then consult a physician immediately.

### **Cradle with RS-232 cable and adaptor**

- 1) Power the cradle only with a power outlet whose voltage matches that marked on the adaptor specified in this manual.
- 2) Avoid conditions that can cause damage or breaks in the power cord. Do not place heavy objects on the power cord. Keep it away from sources of heat. Any of these conditions can damage the power cord, creating the danger of fire and electrical shock.
- 3) Never modify, sharply bend, twist, or pull on the power cord. Doing so creates the danger of fire and electrical shock.
- 4) Use only the AC/DC adaptor and charger specified in this manual. Use of other AC/DC adaptor models or chargers creates the danger of fire and electrical shock.
- 5) Should the power cord ever become severely damaged, contact your original dealer. Use of a damaged electrical cord creates the danger of fire and electrical shock.

### **Moisture**

Keep the Basic Unit and the Barcode Scanner away from vases, planters, cups, glasses and other containers of liquid. Also keep it away from metal. Water and metal getting into the unit creates the danger of fire and electrical shock.

## Safety precautions – Caution!



### Caution!

This symbol indicates information that, if ignored or applied incorrectly, can create the possibility of personal injury or material damage.

---

#### **Foreign objects**

Take care to ensure that metal or combustible objects are not inserted into the openings of the unit. Such objects create the danger of fire and electrical shock.

#### **Location**

- 1) Do not locate the unit on a surface that is unstable or uneven. Doing so creates the danger of the unit falling, which can cause personal injury.
- 2) Do not locate the unit in an area subjected to large amounts of humidity or dust. Doing so creates the danger of fire and electrical shock.
- 3) Do not leave the unit for long periods in a car parked in direct sunlight.

#### **Heavy objects**

Never place heavy objects on top of the unit. Doing so creates the risk of a loss of balance and the object falling, which can cause personal injury.

#### **Exit window**

- 1) Never apply strong pressure to the mirror or subject it to strong impact. Doing so can crack the mirror and create the danger of personal injury.
- 2) Should the mirror ever break, never touch the mirror broken. Doing so can cause personal injury.

#### **Lithium-ion battery**

- 1) Never leave the battery in an area expose to direct sunlight, in a car parked in direct sunlight, or any other very hot area. Doing so creates the danger of heat emission and fire, as well as deterioration of battery performance and shortening of its service life.
- 2) Do not use the battery in areas where static electricity is being generated. Doing so creates the danger of battery heat emission, explosion, and fire.
- 3) Temperature ranges for battery use, charging and storage are specified below. Temperatures outside these ranges create the danger of deterioration of battery performance and shortening of its service life as well as fluid leakage and heat generation.
- 4) Operating Temperature: -20°C to 60°C.
- 5) Charging Temperature: 0°C to 45°C.
- 6) Storage Temperature: -20°C to 45°C.
- 7) Should fluid from the battery accidentally get onto clothing or your skin, immediately rinse it off with clean tap water. Prolonged contact with battery fluid can cause skin irritation.
- 8) Keep the battery out of the reach of small children. Do not let small children remove the battery from the charger or the unit it is powering.

### **Cradle with RS-232 cable and adaptor**

- 1) Keep the power cord away from stoves and other sources of extreme heat. Heat can melt the insulation of the power cord and create the danger of fire and electrical shock.
- 2) Never pull on the power cord when unplugging it. Doing so can damage the cord and create the danger of personal injury, fire and electrical shock. Always hold onto the plug when unplugging it from the wall outlet.
- 3) Never touch the plug while your hands are wet. Doing so can create the danger of electrical shock.
- 4) Be sure to unplug the power cord from the wall outlet before moving the Basic Unit. Failure to do so can result in damage to the power cord caused by pulling it, which creates the danger of fire and electrical shock.
- 5) Be sure to unplug the power cord from the wall outlet before cleaning the Basic Unit and charger.
- 6) Be sure to turn the power off and unplug the power cord after use.
- 7) Unplug the power cord from the wall outlet and clean the area around the plugs at least once a year. If dust collects on the AC/DC adaptor, humidity or moisture may cause a fault in the insulation, which may result in a fire.





# Contents

<b>1 Specifications</b> .....	<b>1</b>
1-1 Technical specifications .....	1
1-2 Default setting for each barcode .....	3
1-3 Decode zone .....	4
<b>2 Get Started</b> .....	<b>5</b>
2-1 Cable connector pin-outs descriptions for cradle .....	5
2-2 Dimensions .....	6
2-3 Parts of the scanner .....	7
2-4 Power on/off handheld unit and charge battery .....	8
2-5 Installation of cable .....	9
2-5-1 PS/2 keyboard cable .....	9
2-5-2 USB cable .....	9
2-5-3 RS-232 cable .....	10
<b>3 Programming menu</b> .....	<b>11</b>
3-1 Example: Programming instruction .....	11
3-2 Description of point coordination and distributed coordination wireless network .....	12
3-2-1 Sketch map of point coordination operating mode .....	12
3-2-2 Sketch map of distributed coordination operating mode .....	12
3-3 Point coordination wireless communication setting .....	13
3-3-1 Point coordination wireless communication setting for handheld unit .....	13
3-3-2 Point coordination wireless communication setting for cradle .....	18
3-3-3 Example .....	20
3-4 Distributed coordination wireless communication setting .....	27
3-4-1 Distributed coordination wireless communication setting for handheld unit .....	27
3-4-2 Distributed coordination wireless communication setting for cradle .....	30
3-4-3 Example .....	31
3-5 Keyboard wedge interface for Cradle .....	36
3-6 RS-232 interface for Cradle .....	40
3-7 USB interface for Cradle .....	43
3-8 Handheld scan & some global settings .....	46
3-9 Indication for handheld unit .....	49
3-10 UPC-A .....	50
3-11 UPC-E .....	52
3-12 UPC-E1 .....	54
3-13 EAN-13 (ISBN/ISSN) .....	56
3-14 EAN-8 .....	59
3-15 Code 39 (Code 32, Trioptic Code 39) .....	61
3-16 Interleaved 2 of 5 .....	64

3-17 Industrial 2 of 5 .....	66
3-18 Matrix 2 of 5 .....	67
3-19 Codabar .....	69
3-20 Code 128 .....	71
3-21 UCC/EAN 128 .....	73
3-22 ISBT 128.....	75
3-23 Code 93 .....	77
3-24 Code 11 .....	79
3-25 MSI/Plessey.....	81
3-26 UK/Plessey .....	83
3-27 China Post.....	85
3-28 China Finance .....	86
3-29 Telepen.....	89
3-30 GS1 DataBar (GS1 DataBar Truncated).....	91
3-31 GS1 DataBar Limited.....	92
3-32 GS1 DataBar Expanded .....	93
3-33 G1-G4 & FN1 substitution string setting .....	94
3-34 G1-G4 string position & Code ID position .....	98
3-35 String transmission .....	99
<b>4 Troubleshooting.....</b>	<b>102</b>
<b>5 Maintenance.....</b>	<b>103</b>
<b>6 ASCII table .....</b>	<b>104</b>
<b>7 Barcode representing non-printable character .....</b>	<b>105</b>
<b>8 Quick setting to point or distributed coordination wireless network.....</b>	<b>106</b>
<b>9 Test Chart .....</b>	<b>107</b>
<b>10 Return default parameters .....</b>	<b>109</b>
<b>11 Display firmware version &amp; radio communication setting.....</b>	<b>110</b>
<b>12 Configuration alphanumeric entry barcode .....</b>	<b>111</b>

# 1 Specifications

## 1-1 Technical specifications

### Handheld unit

<b>Working Range</b>	200 meters <sup>1</sup> (open air)												
<b>Radio Link</b>	430.5 ~ 432.0 MHz , 433.05 ~ 434.79 MHz with adaptive frequency hopping												
<b>Weight</b>	201 g												
<b>Dimensions</b>	Length × Width × Depth: 17.0 × 7.0 × 8.3 cm												
<b>Color</b>	Gray												
<b>Case Material</b>	ABS+TPU												
<b>Exit Window Material</b>	Tempered optical glass												
<b>Indicator</b>	LED, Beeper												
<b>Operating Mode</b>	Handheld												
<b>Programming Method</b>	Manual (reading special barcode)												
<b>Firmware upgrade</b>	Using RSM software, while a cradle unit is required. Refer to RSM user manual.												
<b>Input Voltage</b>	4.75 – 6.5 VDC												
<b>Battery</b>	1400 mAh Lithium-ion battery												
<b>Charge Time</b>	Fully charged (>80%) in 3.5 hours												
<b>Standby Time</b>	5 days												
<b>Operating Time</b>	21 hours (1 scan / 5 s)												
<b>Light Source</b>	650 nm visible laser diode												
<b>Decoding Rate</b>	200 times / second												
<b>Scanning Angle</b>	±60°, ±65°, ±42° (skew, pitch, roll)												
<b>Print Contrast</b>	20% minimum reflection difference												
<b>Decoding Capability</b>	UPC-A, UPC-E, UPC-E1, EAN-13, EAN-8, ISBN (Bookland EAN), ISSN, Code 39, Code 39 full ASCII, Code 32, Trioptic Code 39, Interleaved 2 of 5, Industrial 2 of 5, Matrix 2 of 5, Codabar (NW7), Code 128, UCC/EAN 128, ISBT 128, Code 93, Code 11 (USD-8), MSI/Plessey, UK/Plessey, China Post, China Finance, Telepen, GS1 DataBar (formerly RSS) variants												
<b>Decoding depth &amp; Min. element width</b>	(1 mil = 0.0254 mm) <table style="width: 100%; border: none;"> <thead> <tr> <th style="text-align: left;"><b>Long-Range series</b></th> <th style="text-align: left;"><b>High-Density series</b></th> </tr> </thead> <tbody> <tr> <td>5 mil: 40 - 110 mm</td> <td>3 mil: 5 - 50 mm</td> </tr> <tr> <td>10 mil: 10 - 280 mm</td> <td>10 mil: 10 - 85 mm</td> </tr> <tr> <td>13 mil: 15 - 315 mm</td> <td>13 mil: 10 - 150 mm</td> </tr> <tr> <td>16 mil: 25 - 385 mm</td> <td>16 mil: 25 - 165 mm</td> </tr> <tr> <td>35 mil: 145 - 630 mm</td> <td>35 mil: 145 - 295 mm</td> </tr> </tbody> </table>	<b>Long-Range series</b>	<b>High-Density series</b>	5 mil: 40 - 110 mm	3 mil: 5 - 50 mm	10 mil: 10 - 280 mm	10 mil: 10 - 85 mm	13 mil: 15 - 315 mm	13 mil: 10 - 150 mm	16 mil: 25 - 385 mm	16 mil: 25 - 165 mm	35 mil: 145 - 630 mm	35 mil: 145 - 295 mm
<b>Long-Range series</b>	<b>High-Density series</b>												
5 mil: 40 - 110 mm	3 mil: 5 - 50 mm												
10 mil: 10 - 280 mm	10 mil: 10 - 85 mm												
13 mil: 15 - 315 mm	13 mil: 10 - 150 mm												
16 mil: 25 - 385 mm	16 mil: 25 - 165 mm												
35 mil: 145 - 630 mm	35 mil: 145 - 295 mm												
<b>Temperature</b>	0° to 50°C (32° to 122°F), operating; -40° to 60°C (-40° to 140°F), storage												
<b>Humidity</b>	5% to 95% (non-condensing)												
<b>Safety</b>	Laser safety: EN60825-1, Class 1 EMC: EN55022, EN55024 Electrical Safety: EN60950-1 Drop Resistance: Multiple 1.2 m (3.9 ft.) drops to concrete												

	Sealing: IP52
--	---------------

Note: <sup>1</sup> Test condition: temperature at 27 °C, sunny day, and visibility of 5 kilometers. Natural surroundings significantly affect the communication distance in practice. The distance drops quickly in the rainy, high-humidity, or heavy haze day; radio interference also shortens the communication distance.

## Cradle

<b>Input Voltage</b>	5 ± 0.25 VDC
<b>Cable</b>	Straight 2.0 m (PS/2) / Straight 1.5 m (USB) / Straight 2.0 m (RS-232 )
<b>Dimensions</b>	Length × Width × Depth: 21.3 × 9.7 × 7.5 cm
<b>Weight</b>	189 g (without cable)
<b>Indicator</b>	LED
<b>Case Material</b>	ABS
<b>Programming Method</b>	Manual (reading special barcode)
<b>Firmware Upgrade</b>	PC online using RSM software. Refer to RSM user manual.
<b>Temperature</b>	0° to 50°C (32° to 120°F), Operating; -40° to 60°C (-40° to 140°F), Storage
<b>Humidity</b>	5% to 95% (non-condensing)
<b>Drop Specifications</b>	Unit functions normally after repeated 1.2 m (3.9 ft.) drops to concrete

## 1-2 Default setting for each barcode

Code type	Read enable	Check digit verification	Check digit transmission	Min. code length	Proprietary code ID	AIM code ID
UPC-A	√	√	√	(12) <sup>2</sup>	A	]Em
UPC-E	√	√	√	(8) <sup>2</sup>	D	]Em
UPC-E1	√	√	√	(8) <sup>2</sup>	D	]Em
EAN-13	√	√	√	(13) <sup>2</sup>	A	]Em
EAN-8	√	√	√	(8) <sup>2</sup>	C	]Em
ISBN/ISSN <sup>1</sup>	√	√	√	(13) <sup>2</sup>	B	]Em
Code 39	√	-	-	1	M	]Am
Interleaved 2 of 5	√	-	-	6	I	]Im
Industrial 2 of 5	√	-	-	4	H	]Im
Matrix 2 of 5	√	-	-	6	X	]Im
Codabar	√	-	-	4	N	]Fm
Code 128	√	√	-	1	K	]Cm
UCC/EAN 128	√	√	-	1	K	]Cm
ISBT 128	√	√	-	1	K	]Cm
Code 93	√	√	-	1	L	]Gm
Code 11	-	√	-	4	V	-
MSI/Plessey	-	-	-	4	O	]Mm
UK/Plessey	√	√	-	1	U	]Mm
China Post	√	-	-	(11) <sup>2</sup>	T	]Im
China Finance	√	-	-	(10) <sup>2</sup>	Y	-
Telepen	√	√	-	1	P	]em
GS1 DataBar	√	-	-	(16) <sup>2</sup>	R	]em
GS1 DataBar Truncated <sup>3</sup>	√	-	-	(16) <sup>2</sup>	R	]em
GS1 DataBar Limited	√	-	-	(16) <sup>2</sup>	R	]em
GS1 DataBar Expanded	√	-	-	1	R	]em

Note: <sup>1</sup>The settings for ISBN/ISSN and EAN-13 must be the same.

<sup>2</sup> Fixed-length barcodes.

<sup>3</sup>The settings for GS1 DataBar Truncated and GS1 DataBar must be the same.

# 1-3 Decode zone

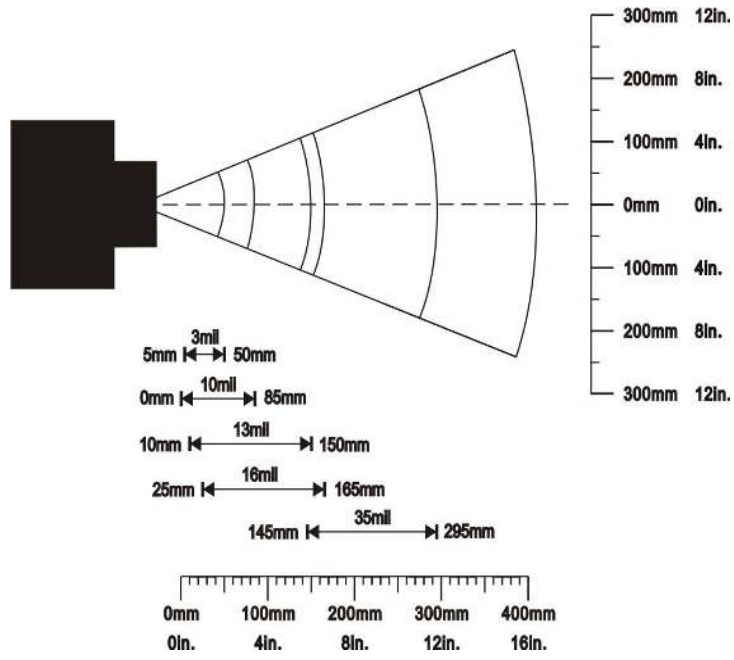

Figure 1-1 High-density series

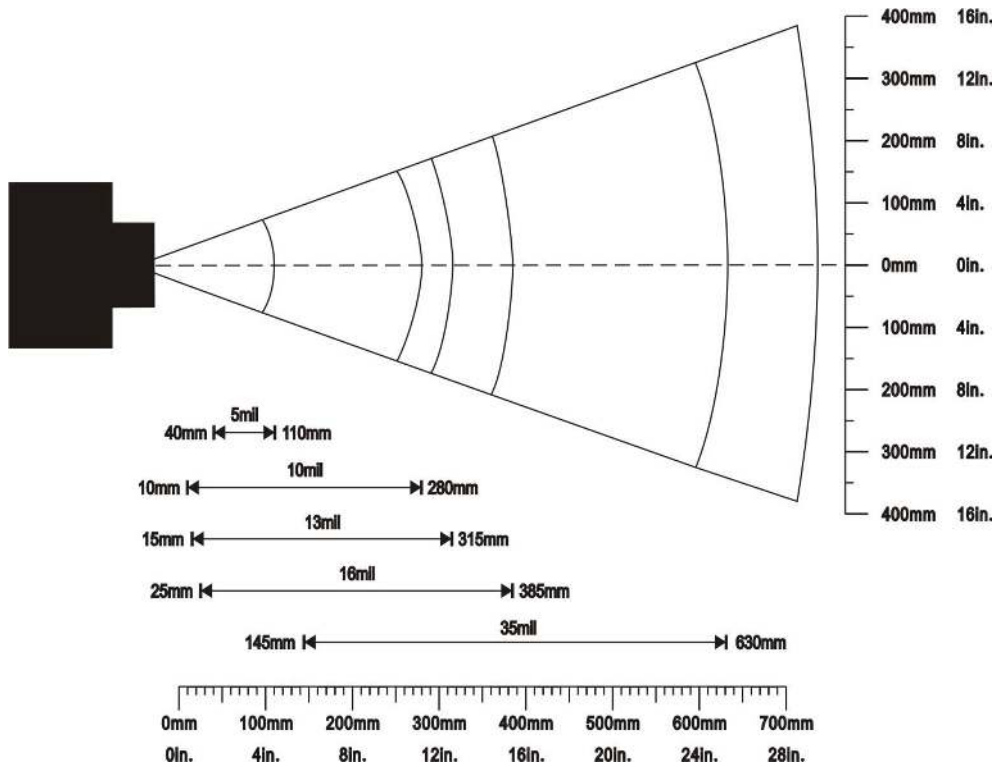

Figure 1-2 Long-range series

## 2 Get Started

### 2-1 Cable connector pin-outs descriptions for cradle

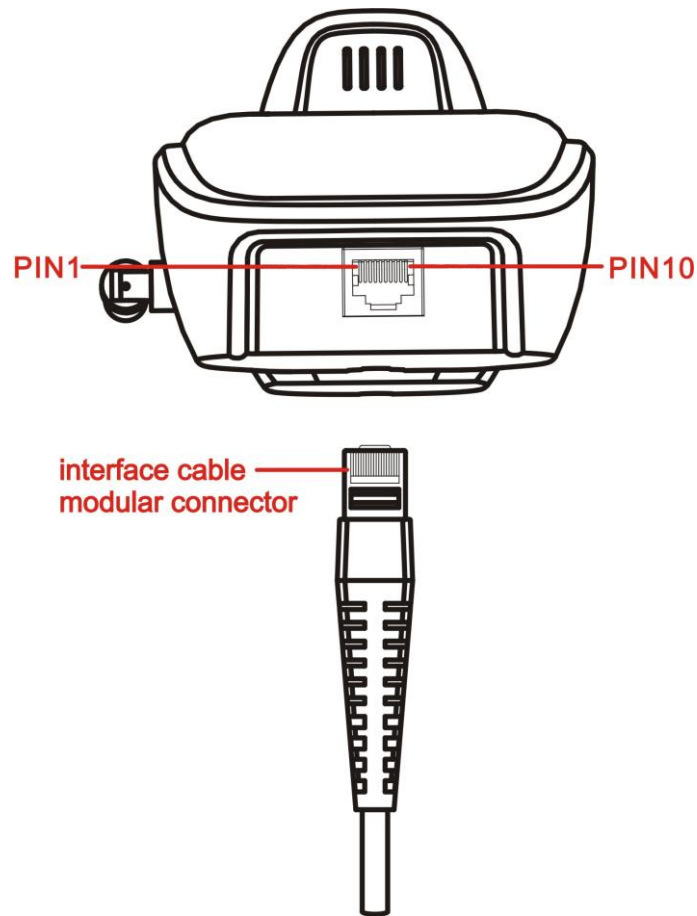

Figure 2-1 Cable connector interface pin-outs

The pin-outs descriptions in Table 1 apply to the cable connector on the cradle and are for reference only.

Table 2-1 Cable connector pin-outs descriptions

Pin	RS232	Keyboard (PS/2)	USB
1	Power (+5V)	Power (+5V)	Power (+5V)
2	+3.3V ( for interface auto selection purpose)	Ground (for interface auto selection purpose)	+3.3V ( for interface auto selection purpose)
3	Ground	Ground	Ground
4	+3.3V ( for interface auto selection purpose)	Reserved	Ground (for interface auto selection purpose)
5	TxD	KeyClock	Reserved
6	RxD	KeyData	Reserved
7	Reserved	TermClock	Reserved
8	Reserved	TermData	Reserved
9	CTS	Reserved	D-
10	RTS	Reserved	D+

Note: Voltage level of all RS232 Pin-outs (RxD, TxD, CTS and RTS) is 0V for logic low and 3.3V for logic high.



# 2-2 Dimensions

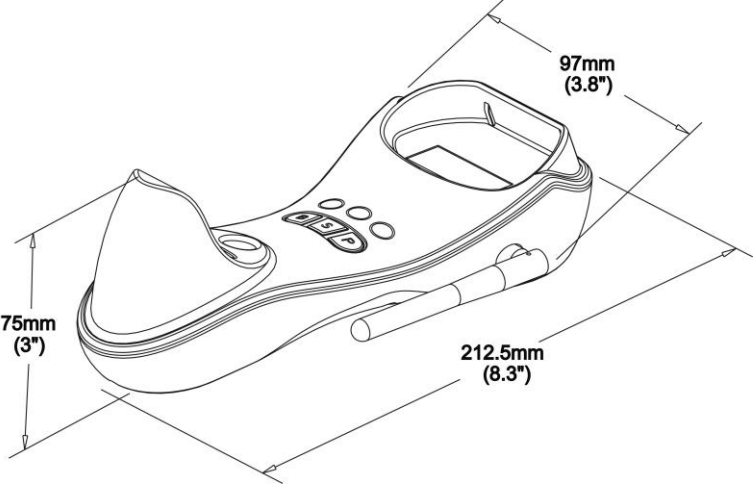
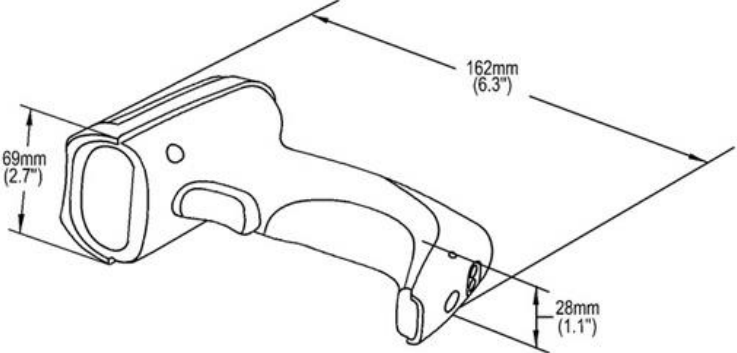
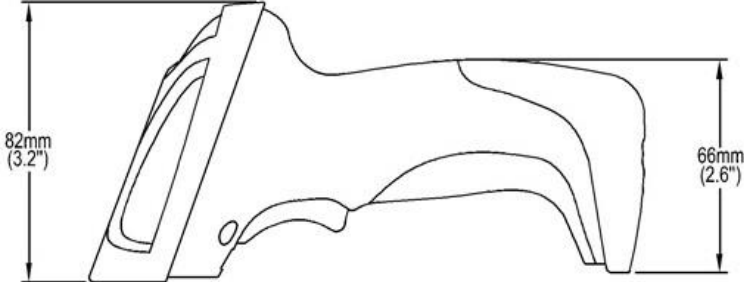

## 2-3 Parts of the scanner

### Handheld unit



- ① Exit window
- ② Trigger
- ③ Red LED (Charging indicator)
- ④ Communication/Charge socket
- ⑤ Power button 
- ⑥ Sound hole
- ⑦ Red LED (Not successful transmission); Blue LED (Power); Green LED (Setting)

### Cradle

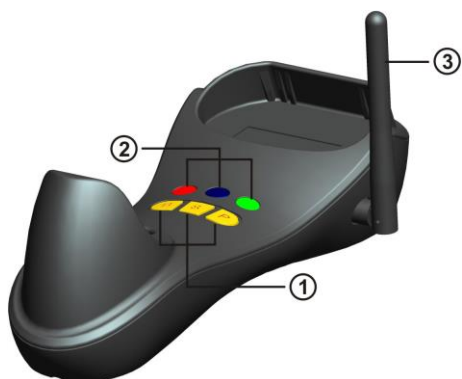

- ① **B** button (Reserved); **S** button (Upgrade / Reset); **P** button (USB Emulate)
- ② Red LED (Initiation failure); Blue LED (Power); Green LED (Data in/Radio frequency hopping indicator)
- ③ Antenna

## 2-4 Power on/off handheld unit and charge battery

Power on handheld unit: Press the power button  for two seconds.

Power off handheld unit: Press the power button  for two seconds.

Charge battery:

1. Please charge the battery before the first time of use. The charge indicator (red LED) on the handheld unit is turned on when the charging is in process. When the charging process completes, the red LED is turned off.
2. Charging time: 3.5 hours for fully charged.
3. You can charge the battery via a USB port on the device or an optional 5V adapter.

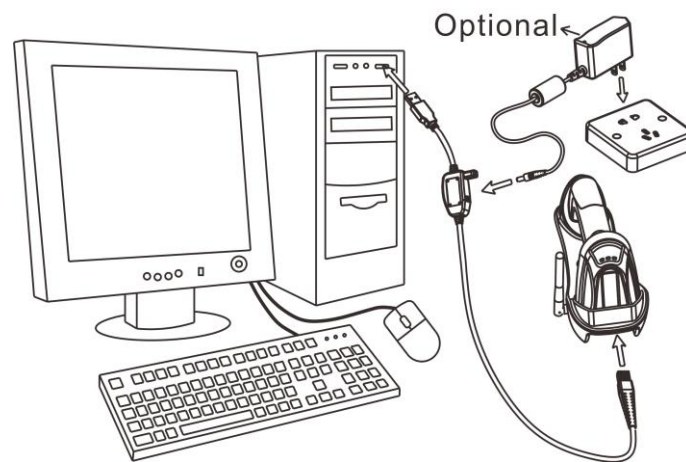

## 2-5 Installation of cable

Note: If any of the below operation is incorrect, turn off the power immediately and check the scanner for any improper connections. Go through all steps again.

### 2-5-1 PS/2 keyboard cable

Plug one end of the PS/2 keyboard cable to the cradle, one end to PS/2 port on PC, and one end to the keyboard.

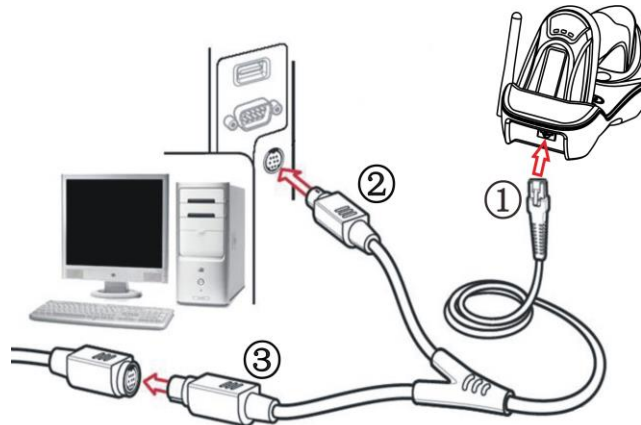

### 2-5-2 USB cable

1. Plug one end of the USB cable to the cradle. Plug the other end into the USB port of the computer.
2. Windows gives message on “new hardware found – USB HID input device found”, then driver will be installed on request.
3. After successfully installing the new hardware, message will be given: “hardware installed successfully and ready to use”.
4. If any problem encounters during the installation process, please unplug the USB cable from the computer and repeat step 1-3.

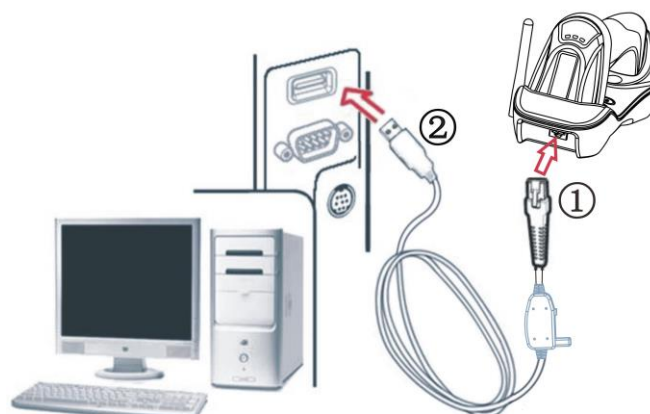

### 2-5-3 RS-232 cable

1. Connect the DB9 serial communication cable with the cradle and the COM port of the computer.
2. Plug the output of the AC/DC adaptor into the power terminal of on the cradle. Plug the AC/DC adaptor provided by the manufacturer into an electrical outlet.

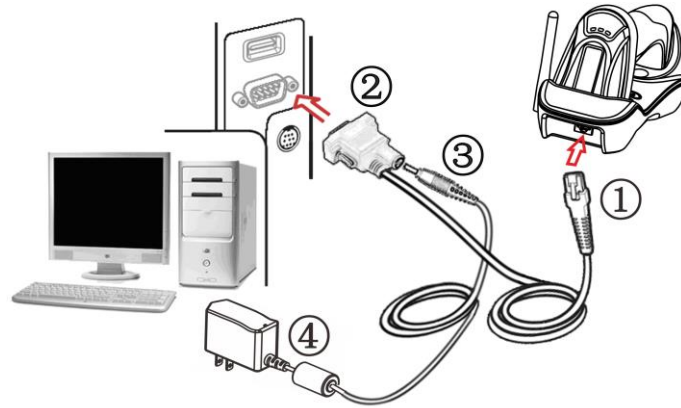

### 3 Programming menu

Note: Throughout the programming bar code menus, the factory default settings are indicated with asterisks (\*).

When the scanner is scanning, ensure the scan line crosses every bar and space of the symbol.



#### 3-1 Example: Programming instruction

Note:

- 1) Only one parameter can be setup at each time.
- 2) During the process of programming, LED is lighting to indicate the programming correctness. LED will go off if any incorrect programming operation performed.
- 3) After each successful programming, LED will go off and the scanner will beep twice.

Two programming modes have been provided as bellows:

##### ① Single-scan setting

Scan the appropriate **Single-scan setting** (e.g. **%0101D00%**) according to the user's demand.

**Example:** To set **Flow control** to be XON/XOFF.

**Steps:** Scan the following barcode.



##### ② Multiple-scan setting

1. Scan the **SETUP** bar code on the parameter setting part.
2. Enter the option mode by scanning the **Option bar code**.
3. To the right of the option barcode, the necessary alphanumeric inputs are listed. See [12 Configuration alphanumeric entry barcode](#).
4. Scan the **END** bar code, listed on the lower right hand corner of each parameter setting part.

**Example:** To set **Flow control** to be XON/XOFF.

**Steps:** Scan the following barcodes in order.



## **3-2 Description of point coordination and distributed coordination wireless network**

The scanner offers two kinds of wireless network topology: point coordination and distributed coordination.

Switch between point coordination topology and distributed coordination topology can be done by scanning corresponding configuration barcode. Note that both cradle and associated handheld units must be configured.

The handheld unit should be placed in the cradle for power charging. It is suggested to prepare an individual cradle for power charging purpose if working as a cluster.

### Notes:

1. In this section, "cluster" denotes an association of a cradle and a number of handheld units.
2. In this section, "RF" is the abbreviation for "radio frequency".

### **3-2-1 Sketch map of point coordination operating mode**

This network topology employs TDM/FDM integrated technique. Different cluster operates in different frequency, suitable for a place where mass data transmission at short intervals is in need. This network topology utilizes a token communication scheme. When working as a cluster, the cradle talks to the associated handheld units one by one. Only one handheld unit can transmit data to the cradle at a time. One single cluster can support up to 16 handheld units. Warning message will be given when the radio communication is out of working range. Due to an operating cradle occupies one selected frequency channel all the time, thus the radio signal generated does interfere the nearby instruments which adapt the same frequency, such as a remote controller of a garage door.

The scanner utilizes 430.5 ~ 432.0MHz, 433.05 ~ 434.79MHz RF wireless communication with LR-433-WPAN wireless communication protocol. LR-433-WPAN protocol first time introduces self-adaptive frequency hopping technique. With this new protocol, a cordless scanner is able to pick up a high-quality RF channel from a cluster of channels in terms of consolidated communication. LR-433-WPAN protocol supports up to 256 handheld units (16 handheld-units/cradle x 16 cradle = 256) within the same effective communication range. A maximum circle of poll time for one cradle with 16 handheld units is 1 second, while the poll time for one cradle with one handheld unit is less than 0.1 second.

### **3-2-2 Sketch map of distributed coordination operating mode**

This network topology employs TDM technique. Different cluster can operate either in the same frequency or in different frequency. One single cluster can support up to 16 handheld units. In the same working area it supports multiple clusters and up to 2000 handheld units operating simultaneously. An operating cradle only occupy the selected frequency channel during data transmitting, so it will not interfere the nearby instruments which adapt the same frequency.

This series of cordless barcode scanner is working at 430MHz ~ 432MHz, 433.05MHz ~ 434.79MHz and is covered by a patent of wireless communication method named LR-433-WPAN wireless communication protocol.

## 3-3 Point coordination wireless communication setting

### 3-3-1 Point coordination wireless communication setting for handheld unit

**Wireless network topology for handheld unit:** There are two kinds of wireless network topology that can be employed: point coordination and distributed coordination.

**Handheld unit RF channel No.:** The scanner offers 16 different radio frequency channels for the data transmission between handheld unit and cradle. The number of channel can be increased.

**Handheld unit ID:** The scanner offers 16 different handheld unit IDs.

**Radio power level for handheld unit:** By selecting, you can change the radio power level for handheld unit.

**Frequency hopping:** If it is enabled, the scanner is able to pick up a higher-performance radio frequency channel from a group of channels in terms of consolidated communication.

#### **Batch data mode:**

**Disable-** Do not batch data. The handheld unit attempts to transmit every scanned barcode. If the transmission is failed, the barcode data is ignored.

**Out-of-range batch -** The handheld unit starts storing barcode data when it loses its connection to a remote device (for example, when a user holding the handheld unit walks out of range). Data transmission is triggered by reestablishing the connection with the cradle (for example, when a user holding the handheld unit walks back into range).

**Standard batch-** The handheld unit starts storing barcode data after “%%%EBM” (*Enter Batch Mode*) is scanned. Data transmission is triggered by scanning “%%%SBD” (*Send Batch Data*).

In Out-of-range batch or Standard batch modes, calculate the number of barcodes the handheld unit can store as follows:

Number of storable barcodes = 16,384 bytes of memory / (number of characters in the barcode + 2).

**Beep on reconnect attempt:** This feature is active only when the Out-of-range batch operating mode is selected. If this feature is enabled, the beeper emits 4 short beeps every 5 seconds while the reconnection attempt is in progress.

**Radio connection checking interval:** This feature is active only when the Out-of-range batch operating mode is selected. The handheld unit checks the radio communication with the cradle once within the time interval.

**Save data at low-battery or power-off:** If it is enabled, the handheld unit will save data to memory while the battery is low or before the power is off.

**Low battery indicator:** If it is enabled, while the power is low, the power LED on the handheld unit flashes 5 times, and the beeper emits 5 beepers for every 10 minutes or 200 scans. In this battery low status, the power LED flashes 2 times by pulling the scanner trigger.

**Enter sleeping mode interval:** If it is enabled, the handheld unit will enter sleeping mode while no operation beyond the time interval defined; the handheld unit will return to normal mode by pulling the scanner trigger.

**Enter transmitting data mode interval:** There is no continuous scanning motion time interval of before the domination handheld unit entering the barcode transmission status. By default when out of range, if there is barcode data awaiting transmission, the handheld unit will try to transmit data to the cradle after



no scanning motion occurs for 5 seconds. This can avoid conflict between transmission of barcode data and scanning barcode motion requested by user.

**VALID/INVALID/LOCK/UNLOCK protocol:** If enabled, the host will validate the data after receiving data from the connected cradle. The host will send VALID/INVALID/LOCK instruction to the cradle after validating the data and the cradle will divert the instruction to the associated handheld unit. The handheld unit will give different audio and visual indication depending on the instruction received from the cradle.

Note that 1 handheld unit is paired with 1 cradle/base unit to work in this mode is suggested, because some pauses may be obvious before data validation.

When a LOCK instruction is received, the decoding function of handheld unit is deactivated and will be reactivated until the receipt of a UNLOCK instruction. The sketch map is shown below:

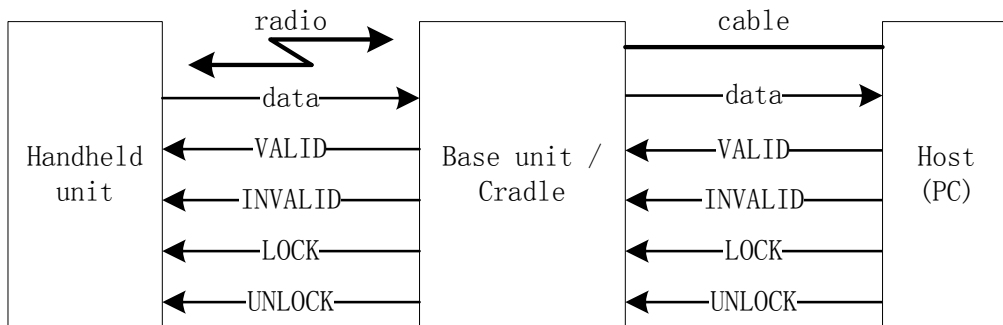

1) Data packet format sent from base unit / cradle to PC.

Byte	0	1	2	3	4	5~(Packet length-1)	Last byte
Segment	Packet length	Reserved	Handheld unit ID	0x22	Data length	Data	Checksum <sup>1</sup>

Note 1: Calculate the sum of the first byte to the byte next to the last byte. The last two bits of the sum are checksum.

2) Format and description of the command packet sent from PC to base unit / cradle.

Command packet	Packet format	Description
VALID	1 byte, 0x33	Validity of data received.
INVALID	1 byte, 0x66	Invalidity of data received.
LOCK	1 byte, 0x77	Data received is abnormal. The decoding function of handheld unit is deactivated.
UNLOCK	1 byte, 0x88	The decoding function of handheld unit is activated.

3) Operations to be performed by the base unit / cradle after receiving the command data packet sent from PC.

Command packet	Operations of base unit / cradle	LED indication
VALID	Send VALID command packet to the handheld unit.	Red LED flashes once, green LED on.
INVALID	Send INVALID command packet to the handheld unit.	Red LED flashes once, green LED off.
LOCK	Send LOCK command packet to the handheld unit, and then wait for the UNLOCK command packet to be sent from PC.	Red LED flashes once, green LED keeps flashing.
UNLOCK	Send UNLOCK command packet to the handheld unit.	Red LED flashes three times, green LED off.
-	The base unit / cradle will enter timeout erroneous state, while no data packet is received within the time interval defined. The base unit / cradle must be reset by pressing the Reset <b>R</b> button to enter the normal working state.	Both the red and the green LED keep flashing.

4) Operations to be performed by the handheld unit after receiving the command packet sent from the base unit / cradle.























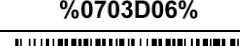

Command packet	Operations of handheld unit	Beeper indication	LED indication
VALID	Return to normal working state	Two beeps with short duration (50ms)	Red LED off, green LED on.
INVALID	Return to normal working state	Two beeps with long duration (200ms)	Red LED on, green LED on.
LOCK	Waiting for UNLOCK command packet from the base unit / cradle, no further operation allowed, e.g. scanning.	Two beeps with long duration (200ms)	Red LED on, green LED flashes.
UNLOCK	Return to normal working state.	Two beeps with short duration (50ms)	Red LED off, green LED off.
-	The handheld unit will enter timeout erroneous state, while no command packet is received within the time interval defined. The handheld unit must be switched off then be switched on to reboot and return normal working state.	Five beeps with short duration (50ms)	Red LED and green LED flash.

**Waiting for command packet interval:** If the option is set as “always”, the handheld unit keeps waiting for command packet sent by the base unit / cradle after sending barcode data to the base unit / cradle. The cradle will also keep waiting for the command packet sent from the host PC after sending the barcode data to the host PC. If there is no command packet received within the defined interval, the base unit / cradle and the handheld unit will enter the lock state, and the handheld unit keeps flashing the LED.



**%SETUP**

SETUP

Option barcode	Option	Alpha. entry	Single-scan setting
Wireless network topology for handheld unit  <b>0700</b>	Point coordination	00*	 %0700D00% *
	Distributed coordination	01	 %0700D01%
Handheld unit RF channel No.  <b>0701</b>	02-16	02-16	
		06*	 %0701D06% *
Handheld unit ID  <b>0702</b>	01-16	01-16	
		01*	 %0702D01% *
Radio power level for handheld unit  <b>0703</b>	10 dbm	01*	 %0703D01% *
	7 dbm	02	 %0703D02%
	5 dbm	03	 %0703D03%
	0 dbm	04	 %0703D04%
	-5 dbm	05	 %0703D05%
	-10 dbm	06	 %0703D06%
	-15 dbm	07	 %0703D07%
Frequency hopping  <b>0704</b>	Disable	00*	 %0704D00% *
	Reserved	01	
Batch data mode  <b>0705</b>	Disable	00*	 %0705D00% *
	Out-of-range batch	01	 %0705D01%
	Standard batch	02	 %0705D02%
Beep on reconnect attempt  <b>0706</b>	Disable	00*	 %0706D00% *
	Enable	01	 %0706D01%
Radio connection checking interval	00-FF <sub>16</sub> (second)	00-FF	



**%SETUP** SETUP

Option barcode	Option	Alpha. entry	Single-scan setting
 <b>0707</b>		03*	 <b>%0707H03%</b> *
Save data at low-battery or power-off  <b>0708</b>	Disable	00*	 <b>%0708D00%</b> *
	Enable	01	 <b>%0708D01%</b>
Low battery indicator  <b>0709</b>	Disable	00	 <b>%0709D00%</b>
	Enable	01*	 <b>%0709D01%</b> *
Enter sleeping mode interval  <b>0710</b>	00-FF <sub>16</sub> (minute)	00-FF <sub>16</sub>	
		0F <sub>16</sub> *	 <b>%0710H0F%</b> *
Enter transmitting data mode interval  <b>0711</b>	00-FF <sub>16</sub> (minute)	00-FF <sub>16</sub>	
		0F <sub>16</sub> *	 <b>%0711H0F%</b> *
VALID/INVALID/LOCK/UNLOCK protocol  <b>0720</b>	Disable	00	 <b>%0720D00%</b> *
	Enable	01*	 <b>%0720D01%</b>
Waiting for command packet interval  <b>0721</b>	Always	00*	 <b>%0721D00%</b> *
	01-99 (100 ms)	01-99	



**%%%END** END

Enter batch mode



**%%%EBM**

Send batch data



**%%%SBD**

Show channel information of handheld unit ✘



**%%%SCI**

Note: The settings indicated with (✘) are valid only when the cradle is in **upgrade ready mode**.

**Cradle entering upgrade ready mode:** Keep pressing the **S** button on the cradle, until the blue LED is flashing. Then three LEDs will all be turned ON, this indicates the cradle being upgrade ready mode.

### 3-3-2 Point coordination wireless communication setting for cradle

**Wireless network topology for cradle:** There are two kinds of wireless network topology that can be employed: point coordination and distributed coordination.

**Cradle RF channel No.:** The scanner offers 16 different radio frequency channels for the data transmission between handheld unit and cradle.

**Bind the first handheld unit ID:** This setting is used to bind the first handheld unit ID. By this setting, the cradle communicates with ONLY one handheld unit with the binding ID. 16 different handheld unit IDs are offered.



**Recruit a next handheld unit ID:** This setting is used to associate one more handheld unit ID with the cradle. 16 different handheld unit IDs are offered.

**Radio power level for cradle:** Refer to Radio power level for handheld unit of [3-3-1 Point coordination wireless communication setting for handheld unit](#).

**Frequency hopping:** Refer to Frequency hopping of [3-3-1 Point coordination wireless communication setting for handheld unit](#).



**%SETUP** SETUP

Option barcode	Option	Alpha. entry	Single-scan setting
Wireless network topology for cradle ✘  <b>0800</b>	Point coordination	00	 %0800D00% *
	Distributed coordination	01*	 %0800D01%
Cradle RF channel No. ✘  <b>0801</b>	02-16	02-16	
		06*	 %0801D06% *
Bind the first handheld unit ID ✘  <b>0802</b>	01-16	01-16	
		01*	 %0802D01% *
Recruit a next handheld unit ID ✘  <b>0803</b>	01-16	01-16	
Radio power level for cradle ✘  <b>0804</b>	10 dbm	01*	 %0804D01% *
	7 dbm	02	 %0804D02%
	5 dbm	03	 %0804D03%
	0 dbm	04	 %0804D04%
	-5 dbm	05	 %0804D05%
	-10 dbm	06	 %0804D06%
	-15 dbm	07	 %0804D07%
Frequency hopping ✘  <b>0805</b>	Disable	00*	 %0805D00% *
	Reserved		



**%%END** END

Show channel information of Cradle ✘



**%%BSCI**

Note: The settings indicated with (✘) are valid only when the cradle is in **upgrade ready mode**.

**Cradle entering upgrade ready mode:** Keep pressing the **S** button on the cradle, until the blue LED is flashing. Then three LEDs will all be turned ON, this indicates the cradle being upgrade ready mode.

### 3-3-3 Example

#### Example 1: One handheld unit connects to one cradle

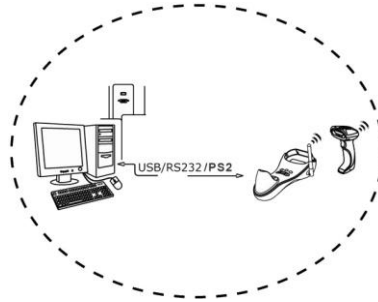

The following takes channel No.2 for instance.

Step 1): Set Wireless network topology for handheld unit of the handheld unit to Point coordination.

 <b>%SETUP</b> <b>0700</b> <b>0</b> <b>0</b>  <b>%%END</b>	or	 <b>%0700D00%</b>
--	----	----------------------

Step 2): Set Handheld unit RF channel No. of the handheld unit to 2.

 <b>%SETUP</b> <b>0701</b> <b>0</b> <b>2</b>  <b>%%END</b>	or	 <b>%0701D02%</b>
--	----	----------------------

Step 3): Set Handheld unit ID of the handheld unit to 3.

 <b>%SETUP</b> <b>0702</b> <b>0</b> <b>3</b>  <b>%%END</b>	or	 <b>%0702D03%</b>
--	----	----------------------

Step 4): Set Wireless network topology for cradle of the cradle to Point coordination.

 <b>%SETUP</b> <b>0800</b> <b>0</b> <b>0</b>	or	 <b>%0800D00%</b>
--	----	----------------------



%%%END

Step 5): Set Cradle RF channel No. of the cradle to 2. Note: The cradle must be in upgrade ready mode. Cradle entering upgrade ready mode: Keep pressing the red button on the cradle, until the blue LED is flashing. Then three LEDs will all be turned ON, this indicates the cradle being upgrade ready mode.



%SETUP



0801



0

or



%0801D02%



2



%%%END

Step 6): Set Bind the first handheld unit ID of the cradle to 3. Note: The cradle must be in upgrade ready mode.



%SETUP



0802



0

or



%0802D03%



3



%%%END

If finish setting, please make the cradle exit upgrade ready mode.

Test barcode:



HELLO11



**Example 2: Two handheld units connect to one cradle**

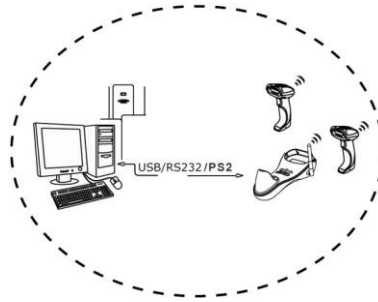

The following takes channel No.2 for instance.

Step 1): Set Wireless network topology for handheld unit of two handheld units to Point coordination.

 %%SETUP 0700 0 0 %%%END	or	 %0700D00%
---	----	---------------

Step 2): Set Handheld unit RF channel No. of two handheld units to 2.

 %%SETUP 0701 0 2 %%%END	or	 %0701D02%
---	----	---------------

Step 3): Set Handheld unit ID of the first handheld unit to 3.

 %%SETUP 0702 0 3 %%%END	or	 %0702D03%
---	----	---------------

Step 4): Set Handheld unit ID of the second handheld unit to 4.

 %%SETUP 0702 0 4 %%%END	or	 %0702D04%
---	----	---------------

Step 5): Set Wireless network topology for cradle of the cradle to Point coordination.

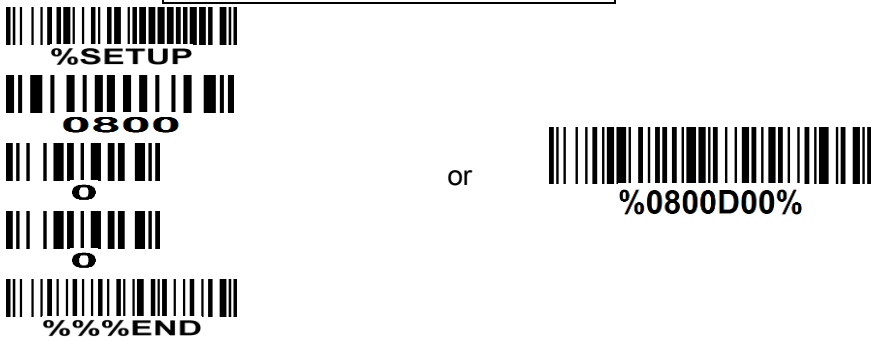

Step 6): Set Cradle RF channel No. of the cradle to 2. Note: The cradle must be in upgrade ready mode. Cradle entering upgrade ready mode: Keep pressing the red button on the cradle, until the blue LED is flashing. Then three LEDs will all be turned ON, this indicates the cradle being upgrade ready mode.

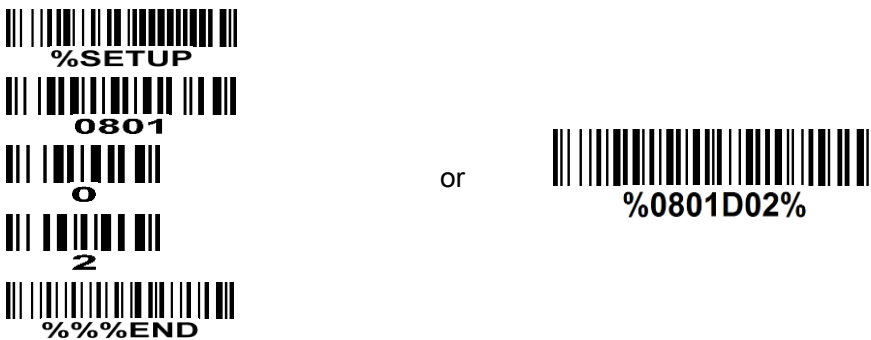

Step 7): Set Bind the first handheld unit ID of the cradle to 3. Note: The cradle must be in upgrade ready mode.

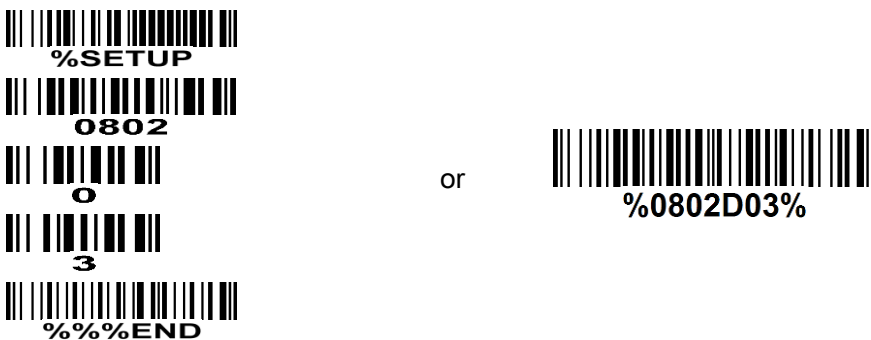

Step 8): Set Recruit a next handheld unit ID of the cradle to 4. Note: The cradle must be in upgrade ready mode.

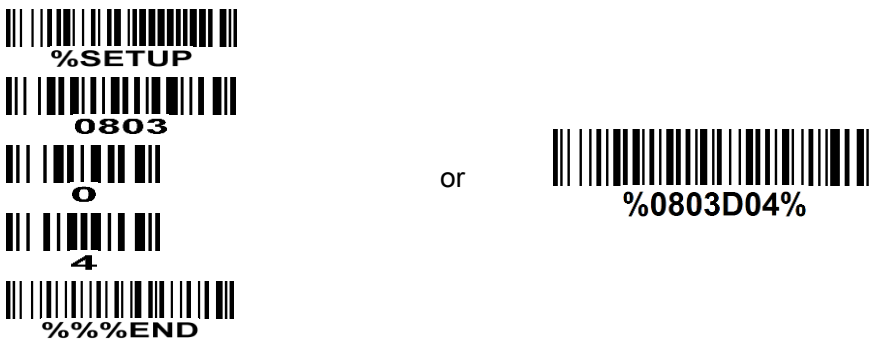

If finish setting, please make the cradle exit upgrade ready mode.

Test barcode:



**Example 3: Three handheld units connect to one cradle**

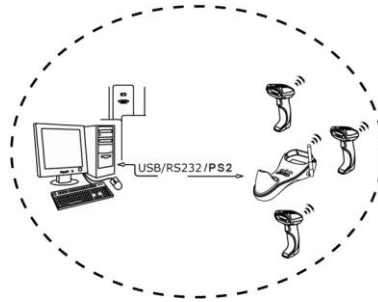

The following takes channel No.2 for instance.

Step 1): Set Wireless network topology for handheld unit of three handheld units to Point coordination.

 %%SETUP 0700 0 0 %%%END	or	 %0700D00%
---	----	---------------

Step 2): Set Handheld unit RF channel No. of three handheld units to 2.

 %%SETUP 0701 0 2 %%%END	or	 %0701D02%
---	----	---------------

Step 3): Set Handheld unit ID of the first handheld unit to 3.

 %%SETUP 0702 0 3 %%%END	or	 %0702D03%
---	----	---------------

Step 4): Set Handheld unit ID of the second handheld unit to 4.

 %%SETUP 0702 0 4 %%%END	or	 %0702D04%
---	----	---------------

Step 5): Set **Handheld unit ID** of the third handheld unit to 5.

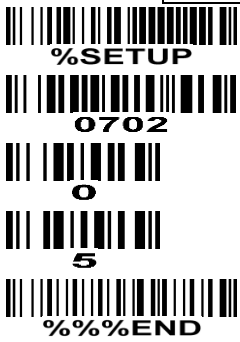

or



Step 6): Set **Wireless network topology for cradle** of the cradle to Point coordination.

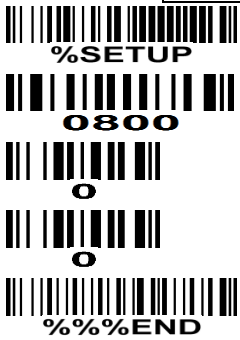

or



Step 7): Set **Cradle RF channel No.** of the cradle to 2. Note: The cradle must be in upgrade ready mode. Cradle entering upgrade ready mode: Keep pressing the red button on the cradle, until the blue LED is flashing. Then three LEDs will all be turned ON, this indicates the cradle being upgrade ready mode.

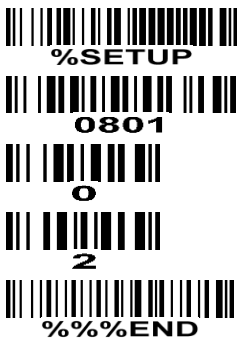

or



Step 8): Set **Bind the first handheld unit ID** of the cradle to 3. Note: The cradle must be in upgrade ready mode.

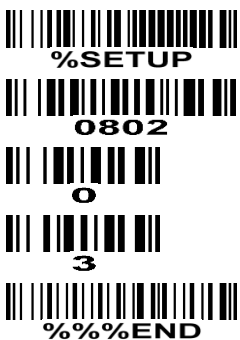

or



Step 9): Set **Recruit a next handheld unit ID** of the cradle to 4. Note: The cradle must be in upgrade ready mode.



or





0



4



%%%END

Step 10): Set Recruit a next handheld unit ID of the cradle to 5. Note: The cradle must be in upgrade ready mode.



%SETUP



0803



0

or



%0803D05%



5



%%%END

If finish setting, please make the cradle exit upgrade ready mode. Test barcode:



HELLO33

## **3-4 Distributed coordination wireless communication setting**

### **3-4-1 Distributed coordination wireless communication setting for handheld unit**

**Wireless network topology for handheld unit:** There are two kinds of wireless network topology that can be employed: point coordination and distributed coordination.

**Handheld unit RF channel No.:** The scanner offers 16 different radio frequency channels for the data transmission between handheld unit and cradle. The number of channel can be increased.

**Handheld unit address:** The scanner offers 2000 different four-digit radio addresses for handheld unit. Note that all scanners used in the same area must have different addresses.

















**Radio power level for handheld unit:** By selecting, you can change the radio frequency power level for handheld unit.

**Interval for radio communication:** An unsuccessful transmission is verified while the handheld unit has not received data beyond the interval. If a RS232 is used, this value should be set not less than feedback delay of RS232 serial port transmission.

**Inform the result of wired transmission for handheld unit:** If this option is enabled, the cradle will only inform the handheld unit the success of data transmission after the data has been successfully transmitted from cradle to host PC.



**%SETUP** SETUP

Option barcode	Options	Alpha. entry	Single-scan setting
Wireless network topology for handheld unit  <b>0700</b>	Point coordination	00	 %0700D00% *
	Distributed coordination	01*	 %0700D01%
Handheld unit RF channel No.  <b>0701</b>	02-16	02-16	
		06*	 %0701D06% *
Handheld unit address  <b>0712</b>	0000-1999	0000-1999	
		0000*	
Radio power level for handheld unit  <b>0703</b>	10 dbm	01*	 %0703D01% *
	7 dbm	02	 %0703D02%
	5 dbm	03	 %0703D03%
	0 dbm	04	 %0703D04%
	-5 dbm	05	 %0703D05%
	-10 dbm	06	 %0703D06%
	-15 dbm	07	 %0703D07%
Interval for radio communication  <b>0713</b>	02-20 (second)	02-20	
		02*	 %0713D02% *
Inform the result of wired transmission for handheld unit  <b>0714</b>	Disable	00*	 %0714D00% *
	Enable	01	 %0714D01%



**%%END** END



Show channel information of handheld unit✕



Note: The settings indicated with (✕) are valid only when the cradle is in **upgrade ready mode**.

### **Cradle entering upgrade ready mode**



Keep pressing the **S** button on the cradle, until the blue LED is flashing. Then three LEDs will all be turned ON, this indicates the cradle being upgrade ready mode.



### 3-4-2 Distributed coordination wireless communication setting for cradle

**Wireless network topology for cradle:** There are two kinds of wireless network topology that can be employed: point coordination and distributed coordination.

**Radio power level for cradle:** By selecting, you can change the radio frequency power level for cradle.

Option barcode	Options	Alpha. entry	Single-scan setting
 %SETUP SETUP Wireless network topology for cradle ✘  0800	Point coordination	00	 %0800D00% *
	Distributed coordination	01*	 %0800D01%
Radio power level for cradle ✘  0804	10 dbm	01*	 %0804D01% *
	7 dbm	02	 %0804D02%
	5 dbm	03	 %0804D03%
	0 dbm	04	 %0804D04%
	-5 dbm	05	 %0804D05%
	-10 dbm	06	 %0804D06%
	-15 dbm	07	 %0804D07%
 %%%END END			

Displaying wireless communication result for cradle ✘



Note: The settings indicated with (✘) are valid only when the cradle is in **upgrade ready mode**.

#### Cradle entering upgrade ready mode

Keep pressing the  button on the cradle, until the blue LED is flashing. Then three LEDs will all be turned ON, this indicates the cradle being upgrade ready mode.

### 3-4-3 Example

#### Example 1: One handheld unit connects to one cradle

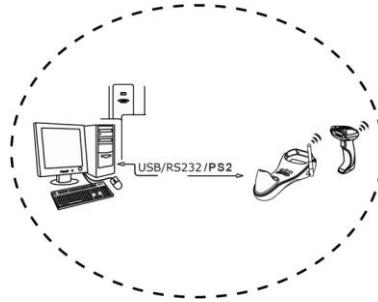

The following takes channel No.5 for instance.

Step 1): Set  of handheld unit to 5.

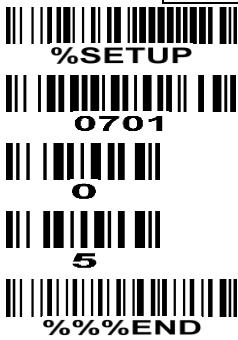

or



Step 2): Set  of handheld unit to 0002.

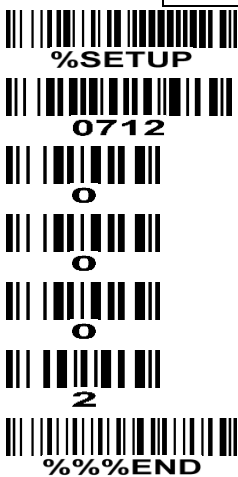

Step 3): Scan the following barcode to bind the handheld unit with the cradle.



Firmly position the handheld unit onto the cradle. Within 10 seconds, two beeps will be emitted to signal that the cradle has been paired to the handheld unit, and the blue LED on the handheld unit will go off. If three beeps are emitted, it indicates unsuccessful pairing between the cradle and the handheld unit; then repeat step 3).

Test barcode:



**Example 2: Two handheld units connect to one cradle**

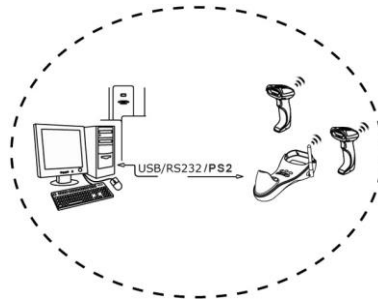

The following takes channel No.5 for instance.

Step 1): Set Handheld unit RF channel No. of handheld unit to 5.

 %SETUP  0701  0  5  %%%END	or	 %0701D05%
--	----	---------------

Step 2): Set Handheld unit address of the first handheld unit to 0002.

  
 %SETUP  
  
 0712  
  
 0  
  
 0  
  
 0  
  
 2  
  
 %%%END

Step 3): Set Handheld unit address of the second handheld unit to 0003.

  
 %SETUP  
  
 0712  
  
 0  
  
 0  
  
 0  
  
 3  
  
 %%%END

Step 4): Make the first handheld unit scan the following barcode to bind the handheld unit with the cradle.



**%%BIND**

Firmly position the handheld unit onto the cradle. Within 10 seconds, two beeps will be emitted to signal that the cradle has been paired to the handheld unit, and the blue LED on the handheld unit will go off. If three beeps are emitted, it indicates unsuccessful pairing between the cradle and the handheld unit; then repeat step 4).

Step 5): Make the second handheld unit scan %%JOIN barcode to pair the second handheld unit with the cradle.



**%%JOIN**

Firmly position the handheld unit onto the cradle. Within 10 seconds, two beeps will be emitted to signal that the cradle has been paired to the handheld unit, and the blue LED on the handheld unit will go off. If three beeps are emitted, it indicates unsuccessful pairing between the cradle and the handheld unit; then repeat step 5).

Test barcode:



**GOOD22**

**Example 3: Three handheld units connect to one cradle**

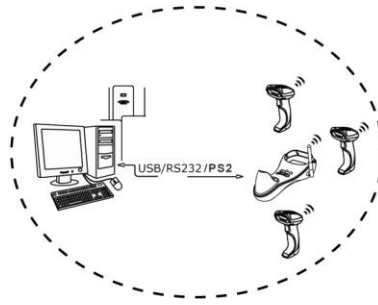

The following takes channel No.5 for instance.

Step 1): Set Handheld unit RF channel No. of handheld unit to 5.

 %SETUP  0701  0  5  %%%END	or	 %0701D05%
--	----	---------------

Step 2): Set Handheld unit address of the first handheld unit to 0002.

  
 %SETUP  
  
 0712  
  
 0  
  
 0  
  
 0  
  
 2  
  
 %%%END

Step 3): Set Handheld unit address of the second handheld unit to 0003.

  
 %SETUP  
  
 0712  
  
 0  
  
 0  
  
 0  
  
 3  
  
 %%%END

Step 3): Set Handheld unit address of the third handheld unit to 0003.

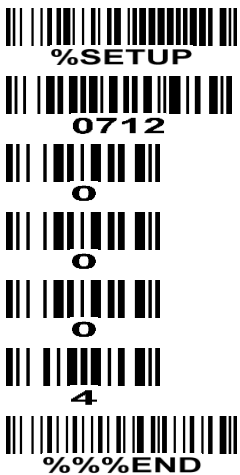

Step 5): Make the first handheld unit scan the following barcode to bind the handheld unit with the cradle.



Firmly position the handheld unit onto the cradle. Within 10 seconds, two beeps will be emitted to signal that the cradle has been paired to the handheld unit, and the blue LED on the handheld unit will go off. If three beeps are emitted, it indicates unsuccessful pairing between the cradle and the handheld unit; then repeat step 5).

Step 6): Make the second handheld unit scan %%JOIN barcode to pair the second handheld unit with the cradle.



Firmly position the handheld unit onto the cradle. Within 10 seconds, two beeps will be emitted to signal that the cradle has been paired to the handheld unit, and the blue LED on the handheld unit will go off. If three beeps are emitted, it indicates unsuccessful pairing between the cradle and the handheld unit; then repeat step 6).

Step 7): Make the third handheld unit scan %%JOIN barcode to pair the third handheld unit with the cradle.



Firmly position the handheld unit onto the cradle. Within 10 seconds, two beeps will be emitted to signal that the cradle has been paired to the handheld unit, and the blue LED on the handheld unit will go off. If three beeps are emitted, it indicates unsuccessful pairing between the cradle and the handheld unit; then repeat step 7).

Test barcode:



### 3-5 Keyboard wedge interface for Cradle

**Keyboard type:** As a keyboard interface, the scanner supports most of the popular PCs and IBM terminals.

**Keyboard layout:** The scanner supports different national keyboard layouts.

**Clock period:** According to the PS/2 protocol, the clock is provided by the device, e.g. keyboard or scanner, with the period between 60 us to 100 us.

**Delay-after-compound-key:** In some rare occasions, machine with low speed PS/2 communication port would require a free time gap following the press/release of the compound key (Shift, Ctrl or Alt).

**Numeric key:**

**Alphabetic key-** the scanner will output code result as alphabetic key.

**Numeric key-** the scanner will output code result as pressing numeric keypad ( '0', '1', '2', '3', '4', '5', '6', '7', '8', '9', '.', '+', '-', '/', '\*' only).

**Alt + keypad-** the scanner will output code result as pressing Alt + numeric key (on keypad). Note that the Num Lock control key must be ON. This setting can be specially adapted for use with different national keyboard layout.

**Power-on simulation:** All of the PCs check the keyboard status during power-on self test. It simulates keyboard timing and passes keyboard present status to the PC during power-on.

**Inter-character delay:** This delay is inserted after each data character transmitted.

**Inter-byte delay:** This delay is inserted after each byte transmitted. Normally a character is comprised of three or above bytes.

**Block trans. delay:** It is a delay timer between barcode data output. This feature is used to transfer continually with shorter barcode data.

**Caps Lock reversion:** By setting enable, the status of Caps Lock key (i.e. being pressed ON or OFF) on the keyboard is simulated in a reversion status.























**Caps Lock override:** If this function is enabled, on AT or AT notebook hosts, the keyboard ignores the state of the Caps Lock key. Therefore, an 'A' in the bar code is sent as an 'A' no matter what the state of the keyboard's Caps Lock key.

#### A guide of setting while the scanned data is incorrectly displayed on the host

- ✚ If some characters are missed or some additional characters are incorrectly displayed on the host, set the Inter-byte delay (0208) to be "01" or greater value.
- ✚ If some capital character (e.g. "A") or compound-key-characters (e.g. "shift+", "Ctrl + ", "Alt+") are displayed incorrectly, set the Delay-after-compound-key to be "01" or greater value.
- ✚ If some digits are incorrectly displayed as some symbol characters (e.g. "1" and "2" are displayed incorrectly as "!" and "@"), set the Clock period (0203) to be greater value (e.g. 04, 05).



**%SETUP** SETUP

Option bar code	Option	Alpha. entry	Single-scan setting
Keyboard type  <b>0201</b>	IBM AT, PS/2	00*	 %0201D00%
	Apple Mac compatibles	01	 %0201D01%
Keyboard layout  <b>0202</b>	USA	00*	 %0202D00%
	Turkish F	01	 %0202D01%
	Turkish Q	02	 %0202D02%
	French	03	 %0202D03%
	Italian	04	 %0202D04%
	Spanish	05	 %0202D05%
	Slovak	06	 %0202D06%
	Denmark	07	 %0202D07%
	Japanese	08	 %0202D08%
	German	09	 %0202D09%
	Belgian	10	 %0202D10%
Russian	11	 %0202D11%	
Clock period  <b>0203</b>	60 us	00	 %0203D00%
	70 us	01	 %0203D01%
	80 us	02*	 %0203D02%
	90 us	03	 %0203D03%
	100 us	04	 %0203D04%





**%SETUP** SETUP

Option bar code	Option	Alpha. entry	Single-scan setting
	200 us	05	 %0203D05%
Delay-after-compound-key  <b>0204</b>	0 ms	00*	 %0204D00%
	10 ms	01	 %0204D01%
	20 ms	02	 %0204D02%
	40 ms	03	 %0204D03%
	80 ms	04	 %0204D04%
Numeric key  <b>0205</b>	Alphabetic key	00*	 %0205D00%
	Numeric keypad	01	 %0205D01%
	Alt + keypad	02	 %0205D02%
Power-on simulation  <b>0206</b>	Disable	00*	 %0206D00%
	Enable	01	 %0206D01%
Inter-character delay  <b>0207</b>	0 ms	00*	 %0207D00%
	5 ms	01	 %0207D01%
	10 ms	02	 %0207D02%
	20 ms	03	 %0207D03%
	40 ms	04	 %0207D04%
	80 ms	05	 %0207D05%
Inter-byte delay  <b>0208</b>	1 ms	00*	 %0208D00%
	2 ms	01	 %0208D01%
	4 ms	02	 %0208D02%



**%SETUP** SETUP

Option bar code	Option	Alpha. entry	Single-scan setting
	8 ms	03	 %0208D03%
Caps Lock reversion  <b>0209</b>	Disable	00*	 %0209D00%
	Enable	01	 %0209D01%
Caps Lock override  <b>0210</b>	Disable	00*	 %0210D00%
	Enable	01	 %0210D01%



**%%END** END

## 3-6 RS-232 interface for Cradle

### Flow control:

**None**-The communication only uses TxD and RxD signals without any hardware or software handshaking protocol.

**RTS/CTS**-If the scanner wants to send the barcode data to host computer, it will issue the RTS signal first, wait for the CTS signal from the host computer, and then perform the normal data communication. If there is no replied CTS signal from the host computer after the timeout duration, the scanner will issue an error indication. By setting (Host idle: Low RTS) or (Host idle: High RTS), the scanner can be set to match the Serial Host RTS line.

**XON/XOFF**-An XOFF character turns the scanner transmission off until the scanner receives an XON character.

**ACK/NAK**-After transmitting data, the scanner expects either an ACK (acknowledge) or NAK (not acknowledge) response from the host. When a NAK is received, the scanner transmits the same data again and waits for either an ACK or NAK. After three unsuccessful attempts to send data when NAKs are received, the scanner issues an error indication and discards the data.

**Inter-character delay:** Refer to Inter-character delay of [3-5 Keyboard wedge interface for Cradle](#).

**Response delay:** This delay is used for serial communication of the scanner when it waits for a handshaking acknowledgment from the host.



**%SETUP**

SETUP

Option bar code	Option	Alpha. entry	Single-scan setting
Flow control  <b>0301</b>	None	00*	 %0301D00%
	RTS/CTS (Host idle: Low RTS)	01	 %0301D01%
	RTS/CTS (Host idle: High RTS)	02	 %0301D02%
	XON/XOFF	03	 %0301D03%
	ACK/NAK	04	 %0301D04%
Inter-character delay  <b>0302</b>	0 ms	00*	 %0302D00%
	5 ms	01	 %0302D01%
	10 ms	02	 %0302D02%
	20 ms	03	 %0302D03%
	40 ms	04	 %0302D04%
	80 ms	05	 %0302D05%
Reserved  <b>0303</b>			
Response delay  <b>0304</b>	01-99 (100 ms)	01-99	
		00*	 %0304D00%
Baud rate  <b>0305</b>	300	00	 %0305D00%
	600	01	 %0305D01%
	1200	02	 %0305D02%
	2400	03	 %0305D03%
	4800	04	 %0305D04%



**%SETUP** SETUP

Option bar code	Option	Alpha. entry	Single-scan setting
	9600	05*	 %0305D05%
	19200	06	 %0305D06%
	38400	07	 %0305D07%
	57600	08	 %0305D08%
	115200	09	 %0305D09%
Parity  <b>0306</b>	None	00*	 %0306D00%
	Odd	01	 %0306D01%
	Even	02	 %0306D02%
Data bit  <b>0307</b>	8 bits	00*	 %0307D00%
	7 bits	01	 %0307D01%
Stop bit  <b>0308</b>	One bit	00*	 %0308D00%
	Two bits	01	 %0308D01%



**%%%END** END

### 3-7 USB interface for Cradle

**USB device type:** When the cradle is connected to a PC with a USB cable, it will be identified as a HID keyboard.

**HID keyboard–** By setting, the scanner is used as a USB HID keyboard emulation device. The keyboard layout setting follows the setting of [keyboard layout](#) in the chapter of Keyboard wedge.

**USB virtual COM–** By setting, the scanner emulate a regular RS232-based COM port. If a Microsoft Windows PC is connected to the scanner, a driver is required to install on the connected PC. The driver will use the next available COM Port number. The driver and the installation guide can be found in the associated CD and on the manufacturer's website. A Windows-based software COM\_Text is recommended to display the barcode data in text format. COM\_Text emulates some kind of serial-key typing.

Note: when changing USB Device Types, the scanner automatically restarts.

**Simple COM Port Emulation-** Please contact the manufacturer for the instruction.

**Keyboard layout:** Refer to [Keyboard layout](#) of [3-5 Keyboard wedge interface for Cradle](#).

**Host comm. port speed:** By selecting, the user can change the output speed of the scanner to match the speed of the host USB communication port. Generally, set 00 or 01 to work with high communication speed. If some output characters of barcode have been missed, the user may need to set 07 or 08 to slow the data transmission speed of the scanner.

**Numeric key:** Refer to [Numeric key](#) of [3-5 Keyboard wedge interface for Cradle](#).



**%SETUP**

SETUP

Option bar code	Option	Alpha. entry	Single-scan setting
USB device type  <b>0901</b>	HID keyboard	00*	 %0901D00%
	HID keyboard for Apple Mac	01	 %0901D01%
	USB virtual COM	02	 %0901D02%
	HID for OPOS/JPOS	03	 %0901D03%
Keyboard layout  <b>0902</b>	USA	00*	 %0902D00%
	Turkish F	01	 %0902D01%
	Turkish Q	02	 %0902D02%
	French	03	 %0902D03%
	Italian	04	 %0902D04%
	Spanish	05	 %0902D05%
	Slovak	06	 %0902D06%
	Denmark	07	 %0902D07%
	Japanese	08	 %0902D08%
	German	09	 %0902D09%
	Belgian	10	 %0902D10%
Russian	11	 %0902D11%	
Inter-character delay  <b>0903</b>	0 ms	00	 %0903D00%
	5 ms	01*	 %0903D01%
	10 ms	02	 %0903D02%



**%SETUP** SETUP

Option bar code	Option	Alpha. entry	Single-scan setting
	20 ms	03	 %0903D03%
	40 ms	04	 %0903D04%
	60 ms	05	 %0903D05%
Numeric key  <b>0904</b>	Alphabetic key	00*	 %0904D00%
	Numeric keypad	01	 %0904D01%
	Alt + keypad	02	 %0904D02%



**%%%END** END



## 3-8 Handheld scan & some global settings

### Scanning mode:

**Good-read off**-The trigger button must be pressed once to activate scanning. The light source of scanner stops scanning when there is a successful reading or no code is decoded after the **Stand-by duration** elapsed.

**Momentary**-The trigger button acts as a switch. Press button to activate scanning and release button to stop scanning. The light source of scanner stops scanning when there is a successful reading or no code is decoded after the **Stand-by duration** elapsed.

**Alternate**-The trigger button acts as a toggle switch. Press button to activate or stop scanning.

**Continue**-The scanner always keeps scanning, and it does not matter when the trigger button is pressed or duration is elapsed.

**Timeout off**-The trigger button must be pressed once to activate scanning. The light source of scanner stops scanning when no code is successful decoded after the **Stand-by duration** elapsed.

**Same barcode delay time:** If a barcode has been scanned and output once successfully, the laser beam must be off or moved away from the barcode beyond delay time to active scanning the same barcode. When this feature is set to be "0xFF", then the delay time is indefinite.

**Double confirm:** If it is enabled, the scanner will require a several times of same-decoded-data to confirm a valid reading.

**Global Max./Min. code length:** These two lengths are defined as the valid range of decoded barcode data length. Make sure that the minimum length setting is no greater than the maximum length setting, or otherwise the labels of the symbol will not be readable. In particular, the same value can be set for both minimum and maximum reading length to force the fixed length barcode decoded.

### Notes:

1. Please set the max./min. length for individual barcode in later sections, if special demand is requested.
2. The number of check digits is included in max./min. code length.
3. These two settings have no effect on the symbols with fixed-length, e.g. UPC-A, UPC-E, EAN-13, EAN-8 and China Post.

**Global G1-G4 string selection:** The scanner offer one or two string group for ALL symbols. By setting one or two digits to indicate which string group you want to apply. You may refer to the chapters of [3-33 G1-G4 & FN1 substitution string setting](#) and [3-34 G1-G4 string position & Code ID position](#).

Example: Group 1 → set 01 or 10. Group 2 and 4 → set 24 or 42.

All valid settings include 00, 01, 02, 03, 04, 10, 11, 12, 13, 14, 20, 21, 22, 23, 24, 30, 31, 32, 33, 34, 40, 41, 42, 43, 44.

**Element amendment:** If it is enabled, the scanner can read the barcode comprised with bars and spaces in different scale.

**Printable character only:** If it is enabled, the scanner will output the printable characters only, i.e. in ASCII from 20H to 7EH.

**Decoder optimization:** If it is enabled, the scanner will optimize the decoder with error correction. This

function is not effective for all types of barcodes.















**%SETUP** SETUP

Option bar code	Option	Alpha. entry	Single-scan setting
Scan mode  <b>0401</b>	Good-read off	00	 %0401D00%
	Momentary	01*	 %0401D01%
	Alternate	02	 %0401D02%
	continue	03	 %0401D03%
	Continue	04	 %0401D04%
	Timeout off	05	 %0401D05%
Standby duration  <b>0402</b>	01-99 (second)	01-99	
		04*	 %0402D04%
Same barcode delay time  <b>0403</b>	00-FF <sub>16</sub> (50 ms)	00-FF <sub>16</sub>	
		00	 %0403H00%
		08*	 %0403H08%
Double confirm  <b>0404</b>	00-09 (00: none )	00-09	
		00*	 %0404D00%
Global max. code length  <b>0405</b>	04-99	04-99	
		99*	 %0405D99%
Global min. code length  <b>0406</b>	01-99	01-99	
		04*	 %0406D04%



**%SETUP** SETUP

Option bar code	Option	Alpha. entry	Single-scan setting
Global G1-G4 string selection  <b>0407</b>	00-44	00-44	
		00*	 %0407D00%
Element amendment  <b>0408</b>	Disable	00	 %0408D00%
	Enable	01*	 %0408D01%
Character output restraint  <b>0409</b>	None	00*	 %0409D00%
	Printable character only	01	 %0409D01%
	Alphanumeric character only	02	 %0409D02%
Decoder optimization  <b>0410</b>	Disable	00	 %0410D00%
	Enable	01*	 %0410D01%



**%%END** END

### 3-9 Indication for handheld unit

**Power on alert:** After power-on the scanner will generate an alert signal to indicate a successful self-test.

**LED indication:** After each successful reading, the LED above the scanner will light up to indicate a good barcode reading.

**Beeper indication:** After each successful reading, the scanner will beep to indicate a good barcode reading, and its beep tone duration is adjustable.

**Beep tone duration:** This parameter can be adjusted for a good reading upon favorite usage.

**Volume of beeper:** This parameter can be adjusted for different level of the volume of the beeper.

Example:

Visual and audio indication of handheld unit for RF transmission

Successful Transmission	Audio (Beeper)	Red LED on handheld unit
Yes	None	Off
No	Three beeps	On



**%SETUP** SETUP

Option bar code	Option	Alpha. entry	Single-scan setting
Power on alert  <b>0501</b>	Disable	00	
	Enable	01*	
LED indication  <b>0502</b>	Disable	00	
	Enable	01*	
Beeper indication  <b>0503</b>	Disable	00	
	Enable	01*	
Beep tone duration  <b>0504</b>	01-09 (10 ms)	01-09	
		05*	
Volume of beeper  <b>0505</b>	Low	00	
	Middle	01	
	High	02*	



**%%%END** END

### 3-10 UPC-A

Read:

Format

System character	Data digits (10 digits)	Check digit
------------------	-------------------------	-------------

**Check digit verification:** The check digit verification is optional.

**Check digit trans.:** By setting Enable, check digit will be transmitted.

**Code ID setting:** Code ID is a one-or-two-character string used to represent the symbol upon a succeeding reading. If you want application to transmit Code ID, you must set **Code ID transmission** to be enabled. Refer to [3-35 String transmission](#).

**Insertion group selection:** Refer to **Global insertion group selection** of [3-8 Hand-held scan & some global settings](#).

**Supplement digits:** The Supplement digits barcode is the supplemental 2 or 5 characters.

Format

System character	Data digits (10 digits)	Check digit	Supplement digits 2 or 5
------------------	-------------------------	-------------	--------------------------

**Truncation/Expansion:**

**Truncate leading zeros-** The leading “0” digits of UPC-A data characters can be truncated when the feature is enabled.

**Expand to EAN13-** It extends to 13-digits with a “0” leading digit when the feature is enabled.

**Truncate system character-** The system character of UPC-A data can be truncated when the feature is enabled.















**Add country code-** The country code (“0” for USA) can be added when the feature is enabled.



Option bar code	Option	Alpha. entry	Single-scan setting
Read  <b>1101</b>	Disable	00	 %1101D00%
	Enable	01*	 %1101D01%
Check digit verification  <b>1102</b>	Disable	00	 %1102D00%
	Enable	01*	 %1102D01%
Check digit trans.  <b>1103</b>	Disable	00	 %1103D00%
	Enable	01*	 %1103D01%



**%SETUP** SETUP

Option bar code	Option	Alpha. entry	Single-scan setting
Code ID setting  <b>1104</b>	00-FF <sub>16</sub> (ASCII)	00-FF <sub>16</sub>	
		<A>*	 %1104H41%
Insert group selection  <b>1105</b>	00-44	00-44	
		00*	 %1105D00%
Supplement digits  <b>1106</b>	None	00*	 %1106D00%
	2 digits	01	 %1106D01%
	5 digits	02	 %1106D02%
	2 or 5 digits	03	 %1106D03%
Truncation/Expansion  <b>1107</b>	None	00*	 %1107D00%
	Truncate leading zeros	01	 %1107D01%
	Expand to EAN-13	02	 %1107D02%
	Truncate system character	03	 %1107D03%
	Add country code	04	 %1107D04%



**%%%END** END

### 3-11 UPC-E

Read:

Format

System character "0"	Data digits (6 digits)	Check digits
----------------------	------------------------	--------------

**Check digit verification:** The check digit verification is optional and made as the sum of the numerical value of the data digits.

**Check digit trans.:** By setting Enable, check digit will be transmitted.

**Code ID setting:** Refer to Code ID setting of [3-10 UPC-A](#).

**Insertion group selection:** Refer to Insertion group selection of [3-10 UPC-A](#).

**Supplement digits:**

Format

System character "0"	Data digits (6 digits)	Check digit	Supplement digits 2 or 5
----------------------	------------------------	-------------	--------------------------

**Truncation/Expansion:**

**Truncate leading zeros-** Refer to Truncation/Expansion of [3-10 UPC-A](#).

**Expand to EAN-13-** It extends to 13-digits with "0" digits when the feature is set to be enabled.

Example: Barcode "0123654",

Output: "0012360000057".

**Expand to UPC-A-** It extends to 12-digits when the feature is set to be enabled.

**Truncate system character-** The system character "0" of UPC-E data can be truncated when the feature is enabled.

















**Add country code-** The country code ("0" for USA) can be added when the feature is enabled.



Option bar code	Option	Alpha. entry	Single-scan setting
Read  1201	Disable	00	
	Enable	01*	
Check digit verification  1202	Disable	00	
	Enable	01*	



**%SETUP** SETUP

Option bar code	Option	Alpha. entry	Single-scan setting
Check digit trans.  <b>1203</b>	Disable	00	 %1203D00%
	Enable	01*	 %1203D01%
Code ID setting  <b>1204</b>	00-FF <sub>16</sub> (ASCII)	00-FF <sub>16</sub>	
		<D>*	 %1204H44%
Insert group selection  <b>1205</b>	00-44	00-44	
		00*	 %1205D00%
Supplement digits  <b>1206</b>	None	00*	 %1206D00% *
	2 digits	01	 %1206D01%
	5 digits	02	 %1206D02%
	2 or 5 digits	03	 %1206D03%
Truncation/Expansion  <b>1207</b>	None	00*	 %1207D00%
	Truncate leading zeros	01	 %1207D01%
	Expand to EAN-13	02	 %1207D02%
	Expand to UPC-A	03	 %1207D03%
	Truncate system character	04	 %1207D04%
	Add country code	05	 %1207D05%



**%%END** END



### 3-12 UPC-E1

Read:

Format

System character "1"	Data digits (6 digits)	Check digits
----------------------	------------------------	--------------

**Check digit verification:** The check digit is optional and made as the sum of the numerical value of the data digits.

**Check digit trans.:** By setting Enable, check digit will be transmitted.

**Code ID setting:** Refer to Code ID setting of [3-10 UPC-A](#).

**Insertion group selection:** Refer to Insertion group selection of [3-10 UPC-A](#).

**Supplement digits:**

Format

System character "1"	Data digits (6 digits)	Check digit	Supplement digits 2 or 5
----------------------	------------------------	-------------	--------------------------

**Truncation/Expansion:**

**Expand to EAN-13-** It extends to 13-digits with "0" digits when the feature is set to be enabled.

**Expand to UPC-A-** It extends to 12-digits when the feature is set to be enabled.

**Truncate system character-** The system character "1" of UPC-E1 data can be truncated when the feature is enabled.

**Add country code-** The country code ("0" for USA) can be added when the feature is enabled.

















%SETUP SETUP

Option bar code	Option	Alpha. entry	Single-scan setting
Read  3401	Disable	00	 %3401D00%
	Enable	01*	 %3401D01%
Check digit verification  3402	Disable	00	 %3402D00%
	Enable	01*	 %3402D01%
Check digit trans.  3403	Disable	00	 %3403D00%
	Enable	01*	 %3403D01%



**%SETUP** SETUP

Option bar code	Option	Alpha. entry	Single-scan setting
Code ID setting  <b>3404</b>	00-FF <sub>16</sub> (ASCII)	00-FF <sub>16</sub>	
		<D>*	 %3404H44%
Insert group selection  <b>3405</b>	00-44	00-44	
		00*	 %3405D00%
Supplement digits  <b>3406</b>	None	00*	 %3406D00%
	2 digits	01	 %3406D01%
	5 digits	02 03	 %3406D02%
	2 or 5 digits		 %3406D03%
Truncation/Expansion  <b>3407</b>	None	00*	 %3407D00%
	Reserved	01	
	Expand to EAN-13	02	 %3407D02%
	Expand to UPC-A	03	 %3407D03%
	Truncate system character	04	 %3407D04%
	Add country code	05	 %3407D05%



**%%%**END END

### 3-13 EAN-13 (ISBN/ISSN)

Read:

Format

Data digits (12 digits)	Check digit
-------------------------	-------------

**Check digit verification:** The check digit is optional and made as the sum of the numerical value of the data digits.

**Check digit transmission:** By setting Enable, check digit will be transmitted.

**EAN-13 code ID setting:** Refer to 

Code ID setting
-----------------

 of *3-10 UPC-A*.

**Insertion group selection:** Refer to 

Insertion group selection
---------------------------

 of *3-10 UPC-A*.

**Supplement digits:**

Format

Data digits (12 digits)	Check digit	Supplement digits 2 or 5
-------------------------	-------------	--------------------------

**ISBN/ISSN conversion:** The ISBN (International Standard Book Number, or Bookland EAN) and ISSN (International Standard Serial Number) are two kinds of barcode for books and magazines. The ISBN is 10 digits with leading “978” and the ISSN is 8 digits with leading “977” of the EAN-13 symbol.

Example:

Barcode “9780194315104”, Output: “019431510X”.

Barcode “9771005180004”, Output: “10051805”.

**ISBN/ISSN code ID setting:** Refer to 

Code ID setting
-----------------

 of *3-10 UPC-A*.







**%SETUP** SETUP

Option bar code	Option	Alpha. entry	Single-scan setting
Read  <b>1301</b>	Disable	00	 %1301D00%
	Enable	01*	 %1301D01%
Check digit verification  <b>1302</b>	Disable	00	 %1302D00%
	Enable	01*	 %1302D01%
Check digit transmission  <b>1303</b>	Disable	00	 %1303D00%
	Enable	01*	 %1303D01%
EAN-13 code ID setting  <b>1304</b>	00-FF <sub>16</sub> (ASCII)	00-FF <sub>16</sub>	
		<A>*	 %1304H41%
Insert group selection  <b>1305</b>	00-44	00-44	
		00*	 %1305D00%
Supplement digits  <b>1306</b>	None	00*	 %1306D00%
	2 digits	01	 %1306D01%
	5 digits	02	 %1306D02%
	2 or 5 digits	03	 %1306D03%



**%SETUP** SETUP

Option bar code	Option	Alpha. entry	Single-scan setting
ISBN/ISSN conversion  <b>1307</b>	Disable	00*	 %1307D00%
	Enable	01	 %1307D01%
ISBN/ISSN code ID setting  <b>1309</b>	00-FF <sub>16</sub> (ASCII)	00-FF <sub>16</sub>	
		<B>*	 %1309H42%



**%%END** END

### 3-14 EAN-8

Read:

Format

Data digits (7 digits)	Check digit
------------------------	-------------

**Check digit verification:** The check digit is optional and made as the sum of the numerical value of the data digits.

**Check digit trans.:** By setting Enable, check digit will be transmitted.

**Code ID setting:** Refer to Code ID setting of [3-10 UPC-A](#).

**Insertion group selection:** Refer to Insertion group selection of [3-10 UPC-A](#).

**Supplement digits:**

Format

Data digits (7 digits)	Check digit	Supplement digits 2 or 5
------------------------	-------------	--------------------------

**Truncation/Expansion:** Refer to Truncation/Expansion of [3-10 UPC-A](#).



**%SETUP** SETUP

Option bar code	Option	Alpha. entry	Single-scan setting
Read  <b>1401</b>	Disable	00	 %1401D00%
	Enable	01*	 %1401D01%
Check digit verification  <b>1402</b>	Disable	00	 %1402D00%
	Enable	01*	 %1402D01%
Check digit trans.  <b>1403</b>	Disable	00	 %1403D00%
	Enable	01*	 %1403D01%
Code ID setting  <b>1404</b>	00-FF <sub>16</sub> (ASCII)	00-FF <sub>16</sub>	
		<C>*	 %1404H43%



**%SETUP** SETUP

Option bar code	Option	Alpha. entry	Single-scan setting
Insert group selection  <b>1405</b>	00-44	00-44	
		00*	 %1405D00%
Supplement digits  <b>1406</b>	None	00*	 %1406D00%
	2 digits	01	 %1406D01%
	5 digits	02	 %1406D02%
	2 or 5 digits	03	 %1406D03%
Truncation/Expansion  <b>1407</b>	None	00*	 %1407D00%
	Truncate leading zero	01	 %1407D01%
	Expand to EAN-13	02	 %1407D02%



**%%%END** END

### 3-15 Code 39 (Code 32, Trioptic Code 39)

Read:

Format

Start character (*)	Data digits (variable)	Check digit (optional)	End character (*)
---------------------	------------------------	------------------------	-------------------

**Check digit verification:** The check digit is optional and made as the sum module 43 of the numerical value of the data digits.

**Check digit transmission:** By setting Enable, check digit will be transmitted.

**Max./Min. code length:** Each symbol has own max./min. code length. If both setting of max./min. code length are "00"s, the setting of global max./min. code length is effective. The length is defined as to the actual barcode data length to be sent. Label with length exceeds these limits will be rejected. Make sure that the minimum length setting is no greater than the maximum length setting, or otherwise all the labels of the symbol will not be readable. In particular, you can see the same value for both minimum and maximum reading length to force the fixed length barcode decoded.

**Code ID setting:** Refer to 

Code ID setting
-----------------

 of [3-10 UPC-A](#).

**Insertion group selection:** Refer to 

Insertion group selection
---------------------------

 of [3-10 UPC-A](#).

**Start/End transmission:** The start and end characters of Code 39 are "\*"s. You can transmit all data digits including two "\*"s.

**\*\* as data character:** By setting Enable, "\*" can be recognized as data character.

**Convert Code 39 to Code 32:** Code 32 is a variant of Code 39 used by the Italian pharmaceutical industry. Note that Code 39 must be enabled in order for this parameter to function.

Format of Code 32

"A" (optional)	Data digits (8 digits)	Check digit
----------------	------------------------	-------------

**Code 32 Prefix "A" transmission:** By setting Enable, the prefix character "A" can be added to all Code 32 barcodes.

**Trioptic Code 39 read:** Trioptic Code 39 is a variant of Code 39 used in the marking of magnetic tapes and computer cartridges. Trioptic Code 39 symbols always contain six characters.

Format

Start character (\$)	Data digits (6 digits)	End character (\$)
----------------------	------------------------	--------------------

**Trioptic Code 39 Start/End transmission:** The start and end characters of Trioptic Code 39 are "\$"s. You can transmit all data digits including two "\$"s.





**%SETUP** SETUP

Option bar code	Option	Alpha. entry	Single-scan setting
Read  <b>1501</b>	Disable	00	 %1501D00%
	Enable	01*	 %1501D01%
Check digit verification  <b>1502</b>	Disable	00*	 %1502D00%
	Enable	01	 %1502D01%
Check digit transmission  <b>1503</b>	Disable	00*	 %1503D00%
	Enable	01	 %1503D01%
Max. code length  <b>1504</b>	00-99	00-99	
		00*	 %1504D00%
Min. code length  <b>1505</b>	00-99	00-99	
		01*	 %1505D01%
Code ID setting  <b>1506</b>	00-FF <sub>16</sub> (ASCII)	00-FF <sub>16</sub>	
		<M>*	 %1506H4D%
Insert group selection  <b>1507</b>	00-44	00-44	
		00*	 %1507D00%
Format  <b>1508</b>	Standard	00*	 %1508D00%
	Full ASCII	01	 %1508D01%
Start/End transmission  <b>1509</b>	Disable	00*	 %1509D00%
	Enable	01	 %1509D01%
“*” as data character	Disable	00*	 %1510D00%



**%SETUP** SETUP

Option bar code	Option	Alpha. entry	Single-scan setting
 <b>1510</b>	Enable	01	 <b>%1510D01%</b>
Convert Code 39 to Code 32  <b>1511</b>	Disable	00*	 <b>%1511D00%</b>
	Enable	01	 <b>%1511D01%</b>
Code 32 Prefix "A" transmission  <b>1512</b>	Disable	00*	 <b>%1512D00%</b>
	Enable	01	 <b>%1512D01%</b>
Trioptic Code 39 read  <b>1513</b>	Disable	00*	 <b>%1513D00%</b>
	Enable	01	 <b>%1513D01%</b>
Trioptic Code 39 Start/End transmission  <b>1514</b>	Disable	00*	 <b>%1514D00%</b>
	Enable	01	 <b>%1514D01%</b>



**%%%**END END

Note 1: If Trioptic Code 39 is set Enable, Code 39 is forced Enable.

Note 2: If Code 39 is set Disable, Trioptic Code 39 is forced Disable.

## 3-16 Interleaved 2 of 5

Read:

Format

Data digits (Variable)	Check digit (optional)
------------------------	------------------------

**Check digit verification:** The check digit is made as the sum module 10 of the numerical values of all data digits. There are two optional check digit algorithms: the specified Uniform Symbol Specification (USS) and the Optical Product Code Council (OPCC).

**Check digit transmission:** By setting Enable, check digit will be transmitted.

**Max./Min. code length:** Refer to 

Max./Min. code length
-----------------------

 of [3-15 Code 39](#).

**Code ID setting:** Refer to 

Code ID setting
-----------------

 of [3-10 UPC-A](#).

**Insertion group selection:** Refer to 

Insertion group selection
---------------------------

 of [3-10 UPC-A](#).



**%SETUP** SETUP

Option bar code	Option	Alpha. entry	Single-scan setting
Read  <b>1601</b>	Disable	00	 %1601D00%
	Enable	01*	 %1601D01%
Check digit verification  <b>1602</b>	Disable	00*	 %1602D00%
	USS	01	 %1602D01%
	OPCC	02	 %1602D02%
Check digit transmission  <b>1603</b>	Disable	00*	 %1603D00%
	Enable	01	 %1603D01%
Max. code length  <b>1604</b>	00-99	00-99	
		99	 %1604D99%
		00*	 %1604D00%
Min. code length  <b>1605</b>	00-99	00-99	
		06*	 %1605D06%
Code ID setting  <b>1606</b>	00-FF <sub>16</sub> (ASCII)	00-FF <sub>16</sub>	
		<I>*	 %1606H49%
Insert group selection  <b>1607</b>	00-44	00-44	
		00*	 %1607D00%



**%%%**END END

### 3-17 Industrial 2 of 5

Read:

Format

Data digits (variable)

Max./Min. code length: Refer to Max./Min. code length of [3-15 Code 39](#).

Code ID setting: Refer to Code ID setting of [3-10 UPC-A](#).

Insertion group selection: Refer to Insertion group selection of [3-10 UPC-A](#).



**%SETUP** SETUP

Option bar code	Option	Alpha. entry	Single-scan setting
Read  <b>1701</b>	Disable	00*	 %1701D00%
	Enable	01	 %1701D01%
Max. code length  <b>1702</b>	00-99	00-99	
		99	 %1702D99%
		00*	 %1702D00%
Min. code length  <b>1703</b>	00-99	00-99	
		00*	 %1703D00%
Code ID setting  <b>1704</b>	00-FF <sub>16</sub> (ASCII)	00-FF <sub>16</sub>	
		<H>*	 %1704H48%
Insert group selection  <b>1705</b>	00-44	00-44	
		00*	 %1705D00%



**%%END** END

## 3-18 Matrix 2 of 5

Read:

Format

Data digits (variable)	Check digit (optional)
------------------------	------------------------

**Check digit verification:** The check digit is made as the sum module 10 of the numerical values of all data digits.

**Check digit transmission:** By setting Enable, check digit will be transmitted.

**Max./Min. code length:** Refer to 

Max./Min. code length
-----------------------

 of *3-15 Code 39*.

**Code ID setting:** Refer to 

Code ID setting
-----------------

 of *3-10 UPC-A*.

**Insertion group selection:** Refer to 

Insertion group selection
---------------------------

 of *3-10 UPC-A*.



**%SETUP** SETUP

Option bar code	Option	Alpha. entry	Single-scan setting
Read  <b>1801</b>	Disable	00	 %1801D00%
	Enable	01*	 %1801D01%
Check digit verification  <b>1802</b>	Disable	00*	 %1802D00%
	Enable	01	 %1802D01%
Check digit transmission  <b>1803</b>	Disable	00*	 %1803D00%
	Enable	01	 %1803D01%
Max. code length  <b>1804</b>	00-99	00-99	
		99	 %1804D99%
		00*	 %1804D00%
Min. code length  <b>1805</b>	00-99	00-99	
		06*	 %1805D06%
Code ID setting  <b>1806</b>	00-FF <sub>16</sub> (ASCII)	00-FF <sub>16</sub>	
		<X>*	 %1806H58%
Insert group selection  <b>1807</b>	00-44	00-44	
		00*	 %1807D00%



**%%END** END

### 3-19 Codabar

Read:

Format

Start	Data digits (variable)	Check digit (optional)	End
-------	------------------------	------------------------	-----

**Check digit verification:** The check digit is made as the sum module 16 of the numerical values of all data digits.

**Check digit transmission:** By setting Enable, check digit will be transmitted.

**Max./Min. code length:** Refer to **Max./Min. code length** of [3-15 Code 39](#).

**Code ID setting:** Refer to **Code ID setting** of [3-10 UPC-A](#).

**Insertion group selection:** Refer to **Insertion group selection** of [3-10 UPC-A](#).

**Start/End type:** Codabar has four pairs of Start/End pattern; you may select one pair to match your application.

**Start/End transmission:** Refer to **Start/End transmission** of [3-15 Code 39](#).

**Start/End character equality:** By setting Enable, the start and end character of a Codabar barcode must be the same.



Option bar code	Option	Alpha. entry	Single-scan setting
Read  <b>1901</b>	Disable	00	
	Enable	01*	
Check digit verification  <b>1902</b>	Disable	00*	
	Enable	01	
Check digit transmission  <b>1903</b>	Disable	00*	
	Enable	01	
Max. code length  <b>1904</b>	00-99	00-99	
		99	
		00*	





**%SETUP** SETUP

Option bar code	Option	Alpha. entry	Single-scan setting
Min. code length  <b>1905</b>	00-99	00-99	
		04	 %1905D04%
		00*	 %1905D00%
Code ID setting  <b>1906</b>	00-FF <sub>16</sub> (ASCII)	00-FF <sub>16</sub>	
		<N>*	 %1906H4E%
Insert group selection  <b>1907</b>	00-44	00-44	
		00*	 %1907D00%
Start/End type  <b>1908</b>	ABCD/ABCD	00*	 %1908D00%
	abcd/abcd	01	 %1908D01%
	ABCD/TN*E	02	 %1908D02%
	abcd/tn*e	03	 %1908D03%
Start/End transmission  <b>1909</b>	Disable	00*	 %1909D00%
	Enable	01	 %1909D01%
Start/End character equality  <b>1910</b>	Disable	00*	 %1910D00%
	Enable	01	 %1910D01%



**%%END** END

## 3-20 Code 128

Read:

Format

Data digits (variable)	Check digit (optional)
------------------------	------------------------

**Check digit verification:** The check digit is made as the sum module 103 of all data digits.

**Check digit transmission:** By setting Enable, check digit will be transmitted.

**Max./Min. code length:** Refer to **Max./Min. code length** of [3-15 Code 39](#).

**Code ID setting:** Refer to **Code ID setting** of [3-10 UPC-A](#).

**Insertion group selection:** Refer to **Insertion group selection** of [3-10 UPC-A](#).

**Truncate leading zeros:** The leading “0” digits of Code 128 barcode characters can be truncated when the feature is enabled.











**%SETUP** SETUP

Option bar code	Option	Alpha. entry	Single-scan setting
Read  <b>2001</b>	Disable	00	 %2001D00%
	Enable	01*	 %2001D01%
Check digit verification  <b>2002</b>	Disable	00	 %2002D00%
	Enable	01*	 %2002D01%
Check digit transmission  <b>2003</b>	Disable	00*	 %2003D00%
	Reserved	01	 %2003D01%
Max. code length  <b>2004</b>	00-99	00-99	
		99	 %2004D99%
		00*	 %2004D00%
Min. code length  <b>2005</b>	00-99	00-99	
		01*	 %2005D01%



**%SETUP** SETUP

Option bar code	Option	Alpha. entry	Single-scan setting
Code ID setting  <b>2006</b>	00-FF <sub>16</sub> (ASCII)	00-FF <sub>16</sub>	
		<K>*	 %2006H4B%
Insert group selection  <b>2007</b>	00-44	00-44	
		00*	 %2007D00%
Truncate leading zeros  <b>2008</b>	Disable	00*	 %2008D00%
	All leading "0"s	01	 %2008D01%
	Only the first "0"	02	 %2008D02%



**%%%**END END

## 3-21 UCC/EAN 128

Read:

Format

Data digits (variable)	Check digit (optional)
------------------------	------------------------

**Check digit verification:** The check digit is made as the sum module 103 of all data digits.

**Check digit transmission:** By setting Enable, check digit will be transmitted.

**Max. /Min. code length:** Refer to 

Max./Min. code length
-----------------------

 of [3-15 Code 39](#).

**Code ID setting:** Refer to 

Code ID setting
-----------------

 of [3-10 UPC-A](#).

**Insertion group selection:** Refer to 

Insertion group selection
---------------------------

 of [3-10 UPC-A](#).

**Truncate leading zeros:** Refer to 

Truncate leading zeros
------------------------

 of [3-20 Code 128](#).



**%SETUP** SETUP

Option bar code	Option	Alpha. entry	Single-scan setting
Read  <b>2501</b>	Disable	00	 %2501D00%
	Enable	01*	 %2501D01%
Check digit verification  <b>2502</b>	Disable	00	 %2502D00%
	Enable	01*	 %2502D01%
Check digit transmission  <b>2503</b>	Disable	00*	 %2503D00%
	Reserved	01	 %2503D01%
Max. code length  <b>2504</b>	00-99	00-99	
		00*	 %2504D00%
Min. code length  <b>2505</b>	00-99	00-99	
		01*	 %2505D01%
Code ID setting  <b>2506</b>	00-FF <sub>16</sub> (ASCII)	00-FF <sub>16</sub>	
		<K>*	 %2506H4B%
Insert group selection  <b>2507</b>	00-44	00-44	
		00*	 %2507D00%
Truncate leading zeros  <b>2508</b>	Disable	00*	 %2508D00%
	All leading "0"s	01	 %2508D01%
	Only the first "0"	02	 %2508D02%



**%%END** END

## 3-22 ISBT 128

Read:

Format

"=" or "&"	Data digits (variable)	Check digit (optional)
------------	------------------------	------------------------

**Check digit verification:** The check digit is made as the sum module 103 of all data digits.

**Check digit transmission:** By setting Enable, check digit will be transmitted.

**Max./Min. code length:** Refer to 

Max./Min. code length
-----------------------

 of [3-15 Code 39](#).

**Code ID setting:** Refer to 

Code ID setting
-----------------

 of [3-10 UPC-A](#).

**Insertion group selection:** Refer to 

Insertion group selection
---------------------------

 of [3-10 UPC-A](#).



**%SETUP** SETUP

Option bar code	Option	Alpha. entry	Single-scan setting
Read  <b>3301</b>	Disable	00	 %3301D00%
	Enable	01*	 %3301D01%
Check digit verification  <b>3302</b>	Disable	00	 %3302D00%
	Enable	01*	 %3302D01%
Check digit transmission  <b>3303</b>	Disable	00*	 %3303D00%
	Reserved	01	 %3303D01%
Max. code length  <b>3304</b>	00-99	00-99	
		00*	 %3304D99%
Min. code length  <b>3305</b>	00-99	00-99	
		01*	 %3305D01%
Code ID setting  <b>3306</b>	00-FF <sub>16</sub> (ASCII)	00-FF <sub>16</sub>	
		<K>*	 %3306H4B%
Insert group selection  <b>3307</b>	00-44	00-44	
		00*	 %3307D00%



**%%END** END

## 3-23 Code 93

Read:

Format

Data digits (variable)	2 check digits (optional)
------------------------	---------------------------

**Check digit verification:** The check digit is made as the sum module 47 of the numerical values of all data digits.

**Check digit transmission:** By setting Enable, check digit will be transmitted.

**Max./Min. code length:** Refer to 

Max./Min. code length
-----------------------

 of [3-15 Code 39](#).

**Code ID setting:** Refer to 

Code ID setting
-----------------

 of [3-10 UPC-A](#).

**Insertion group selection:** Refer to 

Insertion group selection
---------------------------

 of [3-10 UPC-A](#).





**%SETUP** SETUP

Option bar code	Option	Alpha. entry	Single-scan setting
Read  <b>2101</b>	Disable	00	 %2101D00%
	Enable	01*	 %2101D01%
Check digit verification  <b>2102</b>	Disable	00	 %2102D00%
	Enable	01*	 %2102D01%
Check digit transmission  <b>2103</b>	Disable	00*	 %2103D00%
	Enable	01	 %2103D01%
Max. code length  <b>2104</b>	00-99	00-99	
		00*	 %2104D00%
Min. code length  <b>2105</b>	00-99	00-99	
		01*	 %2105D01%
Code ID setting  <b>2106</b>	00-FF <sub>16</sub> (ASCII)	00-FF <sub>16</sub>	
		<L>*	 %2106H4C%
Insert group selection  <b>2107</b>	00-44	00-44	
		00*	 %2107D00%



**%%END** END

## 3-24 Code 11

Read:

Format

Data digits (variable)	Check digit 1 (optional )	Check digit 2 (optional)
------------------------	---------------------------	--------------------------

**Check digit verification:** The check digit is presented as the sum module 11 of all data digits.

**Check digit transmission:** By setting Enable, check digit 1 and check digit 2 will be transmitted upon your selected check digit verification method.

**Max./Min. code length:** Refer to 

Max./Min. code length
-----------------------

 of [3-15 Code 39](#).

**Code ID setting:** Refer to 

Code ID setting
-----------------

 of [3-10 UPC-A](#).

**Insertion group selection:** Refer to 

Insertion group selection
---------------------------

 of [3-10 UPC-A](#).



**%SETUP** SETUP

Option bar code	Option	Alpha. entry	Single-scan setting
Read  <b>2201</b>	Disable	00*	 %2201D00%
	Enable	01	 %2201D01%
Check digit verification  <b>2202</b>	Disable	00	 %2202D00%
	One digit	01*	 %2202D01%
	Reserved	02	
	Reserved	03	
Check digit transmission  <b>2203</b>	Disable	00*	 %2203D00%
	Enable	01	 %2203D01%
Max. code length  <b>2204</b>	00-99	00-99	
		00*	 %2204D00%
Min. code length  <b>2205</b>	00-99	00-99	
		00*	 %2205D00%
Code ID setting  <b>2206</b>	00-FF <sub>16</sub> (ASCII)	00-FF <sub>16</sub>	
		<V>*	 %2206H56%
Insert group selection  <b>2207</b>	00-44	00-44	
		00*	 %2207D00%



**%%END** END

## 3-25 MSI/Plessey

Read:

Format

Data digits (variable)	Check digit 1 (optional)	Check digit 2 (optional)
------------------------	--------------------------	--------------------------

**Check digit verification:** The MSI/Plessey has one or two optional check digits. There are three methods of verifying check digits, i.e. Mod 10, Mod 10/10 and Mod 10/11. The check digit 1 and check digit 2 will be calculated as the sum module 10 or 11 of the data digits.

**Check digit transmission:** By setting Enable, check digit 1 and check digit 2 will be transmitted upon your selected check digit verification method.

**Max./Min. code length:** Refer to 

Max./Min. code length
-----------------------

 of [3-15 Code 39](#).

**Code ID setting:** Refer to 

Code ID setting
-----------------

 of [3-10 UPC-A](#).

**Insertion group selection:** Refer to 

Insertion group selection
---------------------------

 of [3-10 UPC-A](#).



**%SETUP** SETUP

Option bar code	Option	Alpha. entry	Single-scan setting
Read  <b>2301</b>	Disable	00*	 %2301D00%
	Enable	01	 %2301D01%
Check digit verification  <b>2302</b>	Disable	00*	 %2302D00%
	1 digit (Mod 10)	01	 %2302D01%
	2 digits (Mod 10/10)	02	 %2302D02%
	2 digits (Mod 10/11)	03	 %2302D03%
Check digit transmission  <b>2303</b>	Disable	00*	 %2303D00%
	Enable	01	 %2303D01%
Max. code length  <b>2304</b>	00-99	00-99	
		00*	 %2304D00%
Min. code length  <b>2305</b>	00-99	00-99	
		00*	 %2305D04%
Code ID setting  <b>2306</b>	00-FF <sub>16</sub> (ASCII)	00-FF <sub>16</sub>	
		<O>*	 %2306H4F%
Insert group selection  <b>2307</b>	00-44	00-44	
		00*	 %2307D00%



**%%END** END

## 3-26 UK/Plessey

Read:

Format

Data digits (variable)	2 check digits (optional)
------------------------	---------------------------

**Check digit verification:** The UK/Plessey has one or two optional check digits. The check digit 1 and check digit 2 will be calculated as the sum module 10 or 11 of the data digits.

**Check digit transmission:** By setting Enable, check digit will be transmitted.

**Max./Min. code length:** Refer to 

Max./Min. code length
-----------------------

 of [3-15 Code 39](#).

**Code ID setting:** Refer to 

Code ID setting
-----------------

 of [3-10 UPC-A](#).

















**Insertion group selection:** Refer to 

Insertion group selection
---------------------------

 of [3-10 UPC-A](#).



**%SETUP** SETUP

Option bar code	Option	Alpha. entry	Single-scan setting
Read  <b>2401</b>	Disable	00*	 %2401D00%
	Enable	01	 %2401D01%
Check digit verification  <b>2402</b>	Disable	00	 %2402D00%
	Enable	01*	 %2402D01%
Check digit transmission  <b>2403</b>	Disable	00*	 %2403D00%
	Enable	01	 %2403D01%
Max. code length  <b>2404</b>	00-99	00-99	
		00*	 %2404D00%
Min. code length  <b>2405</b>	00-99	00-99	
		01*	 %2405D01%
Code ID setting  <b>2406</b>	00-FF <sub>16</sub> (ASCII)	00-FF <sub>16</sub>	
		<U>*	 %2406H55%
Insert group selection  <b>2407</b>	00-44	00-44	
		00*	 %2407D00%



**%%END** END

### 3-27 China Post

Read:

Format

11 Data digits

Max. /Min. code length: Refer to Max./Min. code length of [3-15 Code 39](#). The code length of China Post is 11.

Code ID setting: Refer to Code ID setting of [3-10 UPC-A](#).

Insertion group selection: Refer to Insertion group selection of [3-10 UPC-A](#).



%SETUP SETUP

Option bar code	Option	Alpha. entry	Single-scan setting
Read  2601	Disable	00	 %2601D00%
	Enable	01*	 %2601D01%
Reserved  2602			
Reserved  2603			
Max. code length  2604	00-99	00-99	
		11*	 %2604D11%
Min. code length  2605	00-99	00-99	
		11*	 %2605D11%
Code ID setting  2606	00-FF <sub>16</sub> (ASCII)	00-FF <sub>16</sub>	
		<T>*	 %2606H54%
Insert group selection  2607	00-44	00-44	
		00*	 %2607D00%



%%%END END



### 3-28 China Finance

*Note: This type of barcode is not Omni-directionally decodable. The encodable character set includes numeric 0 to 9. Among the symbol of 0 to 9, 0 and 2, 4 and 9, 5 and 8, 6 and 7, have the symmetrical pattern; the pattern of 1 and 3 is symmetrical.*

**Read:**

Format

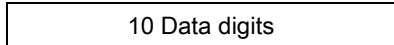

**Max./Min. code length:** Refer to **Max./Min. code length** of [3-15 Code 39](#).

**Check digit verification:** The check digit is made as the sum module 10 of the numerical values of all data digits.

**Leading character 5/6/7/8/9 converted to A/B/C/D/E:** By setting, leading character 5/6/7/8/9 can be converted to A/B/C/D/E.























**Leading character assignment:** By setting, only the barcode with the assigned leading character can be output.

**Code ID setting:** Refer to **Code ID setting** of [3-10 UPC-A](#).

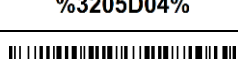
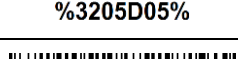
**Insertion group selection:** Refer to **Insertion group selection** of [3-10 UPC-A](#).



**%SETUP** SETUP

Option bar code	Option	Alpha. entry	Single-scan setting
Read  <b>3201</b>	Disable	00	 %3201D00%
	Enable	01*	 %3201D01%
Max. code length  <b>3202</b>	00-99	00-99	
		10*	 %3202D10%
Min. code length  <b>3203</b>	00-99	00-99	
		10*	 %3203D10%
Check digit verification  <b>3204</b>	Disable	00*	 %3204D00%
	Reserved	01	 %3204D01%
Leading character 5/6/7/8/9 converted to A/B/C/D/E  <b>3205</b>	Disable	00	 %3205D00%
	Enable	01*	 %3205D01%
	Only 5 converted to A	02	 %3205D02%
	Only 6 converted to B	03	 %3205D03%
	Only 7 converted to C	04	 %3205D04%
	Only 8 converted to D	05	 %3205D05%
	Only 9 converted to E	06	 %3205D06%
Leading character assignment  <b>3206</b>	Disable	00	 %3206D00%
	Assigned to 0	01*	 %3206D01%
	Assigned to 5(A)	02	 %3206D02%
	Assigned to 6(B)	03	 %3206D03%



**%SETUP** SETUP

Option bar code	Option	Alpha. entry	Single-scan setting
	Assigned to 7(C)	04	 %3206D04%
	Assigned to 8(D)	05	 %3206D05%
	Assigned to 9(E)	06	 %3206D06%
	Assigned to 1	07	 %3206D07%
	Assigned to 2	08	 %3206D08%
	Assigned to 3	09	 %3206D09%
	Assigned to 4	10	 %3206D10%
Code ID setting  <b>3207</b>	00-FF <sub>16</sub> (ASCII)	00-FF <sub>16</sub>	
		<Y>*	 %3207H59%
Insert group selection  <b>3208</b>	00-44	00-44	
		00*	 %3208D00%



**%%END** END



**%%LLDS**

**Laser Light Direction Setting:** By scanning the barcode above, the decoding direction of the scanner's laser light is from left to right. By scanning the up-side-down barcode above, the decoding direction of the scanner's laser light is from right to left.

### 3-29 Telepen

**Read:**

Format

Start character ( _ )	Data digits (variable)	Check digit	End character ( z )
-----------------------	------------------------	-------------	---------------------

**Check digit verification:** The check digit verification is optional.

**Check digit transmission:** By setting Enable, check digit will be transmitted.

**Max./Min. code length:** Refer to 

Max./Min. code length
-----------------------

 of [3-15 Code 39](#).

**Code ID setting:** Refer to 

Code ID setting
-----------------

 of [3-10 UPC-A](#).

**Insertion group selection:** Refer to 

Insertion group selection
---------------------------

 of [3-10 UPC-A](#).



















**Encode character set type:** Two options. Same Telepen symbol, with different option, is associated with different data output.

**Alphanumeric-** Supports both letters and numbers within the data source.

**Numeric-** Supports only numbers within the data source and ignores all letters.



%SETUP SETUP

Option barcode	Option	Alpha. entry	Single-scan setting
Read  <b>3501</b>	Disable	00	 %3501D00%
	Enable	01*	 %3501D01% *
Check digit verification  <b>3502</b>	Disable	00	 %3502D00%
	Enable	01*	 %3502D01% *
Check digit transmission  <b>3503</b>	Disable	00*	 %3503D00% *
	Enable	01	 %3503D01%
Max. code length  <b>3504</b>	00-99	00-99	
		00*	 %3504D00% *
Min. code length  <b>3505</b>	00-99	00-99	
		01*	 %3505D01% *
Code ID setting  <b>3506</b>	00-FF <sub>16</sub>	00-FF <sub>16</sub>	
		<P>*	 %3506H50% *
Insertion group selection  <b>3507</b>	00-66	00-66	
		00*	 %3507D00% *
Encode character set type  <b>3508</b>	Alphanumeric	00*	 %3508D00% *
	Numeric	01	 %3508D01%



%%%END END

### 3-30 GS1 DataBar (GS1 DataBar Truncated)

GS1 DataBar Truncated is structured and encoded the same as the standard GS1 DataBar format, except its height is reduced to a 13 modules minimum; while GS1 DataBar should have a height greater than or equal to 33 modules.

**Read:**

Format

16 Data digits

**Code ID setting:** Refer to Code ID setting of [3-10 UPC-A](#).

**Insertion group selection:** Refer to Insertion group selection of [3-10 UPC-A](#).

**Conversion:**

**UCC/EAN 128-** Refer to Code ID transmission of [3-35 String transmission](#), ]Cm will be identified as AIM ID.

**UPC-A or EAN-13-** Barcode beginning with a single zero as the first digit has the leading “010” stripped and the barcode reported as EAN-13. Barcode beginning with two or more zeros but not six zeros has the leading “0100” stripped and the barcode reported as UPC-A.

Option bar code	Option	Alpha. entry	Single-scan setting
 <b>2701</b>	Disable	00	 %2701D00%
	Enable	01*	 %2701D01%
 <b>2702</b>	00-FF <sub>16</sub> (ASCII)	00-FF <sub>16</sub>	
		<R>*	 %2702H52%
 <b>2703</b>	00-44	00-44	
		00*	 %2703D00%
 <b>2704</b>	None	00*	 %2704D00%
	UCC/EAN 128	01	 %2704D01%
	UPC-A or EAN-13	02	 %2704D02%

  
%%%END END

### 3-31 GS1 DataBar Limited

Read:

Format

16 Data digits











Code ID setting: Refer to Code ID setting of [3-10 UPC-A](#).

Insertion group selection: Refer to Insertion group selection of [3-10 UPC-A](#).

Conversion: Refer to Conversion of [3-30 GS1 DataBar \(GS1 DataBar Truncated\)](#).



**%SETUP** SETUP

Option bar code	Option	Alpha. entry	Single-scan setting
Read  <b>2801</b>	Disable	00	 %2801D00%
	Enable	01*	 %2801D01%
Code ID setting  <b>2802</b>	00-FF <sub>16</sub> (ASCII)	00-FF <sub>16</sub>	
		<R>*	 %2802H52%
Insert group selection  <b>2803</b>	00-44	00-44	
		00*	 %2803D00%
Conversion  <b>2804</b>	None	00*	 %2804D00%
	UCC/EAN 128	01	 %2804D01%
	UPC-A or EAN-13	02	 %2804D02%



**%%%END** END

### 3-32 GS1 DataBar Expanded

Read:

Format

Data characters (variable)

**Code ID setting:** Refer to Code ID setting of [3-10 UPC-A](#).

**Insertion group selection:** Refer to Insertion group selection of [3-10 UPC-A](#).

**Conversion:**

**UCC/EAN 128-** Refer to Code ID transmission of [3-35 String transmission](#), ]Cm will be identified as AIM ID.



**%SETUP** SETUP

Option bar code	Option	Alpha. entry	Single-scan setting
Read  <b>2901</b>	Disable	00	 %2901D00%
	Enable	01*	 %2901D01%
Max. code length  <b>2902</b>	00-99	00-99	
		00*	 %2902D00%
Min. code length  <b>2903</b>	00-99	00-99	
		01*	 %2903D01%
Code ID setting  <b>2904</b>	00-FF <sub>16</sub> (ASCII)	00-FF <sub>16</sub>	
		<R>*	 %2904H52%
Insert group selection  <b>2905</b>	00-44	00-44	
		00*	 %2905D00%
Conversion  <b>2906</b>	None	00*	 %2906D00%
	UCC/EAN 128	01	 %2906D01%



**%%%END** END



### 3-33 G1-G4 & FN1 substitution string setting

Format of barcode data transmission:

Prefix	Code name	Preamble	Code ID	Code length	Code data	Code ID	Postamble	Suffix
--------	-----------	----------	---------	-------------	-----------	---------	-----------	--------

**Suffix string setting:** The <enter> key is represented in different ASCII when it is applied by different OS. For a Windows/DOS OS, <enter> is represented as <CR><LF> (0x0D 0x0A); for an Apple MAC OS, <enter> is represented as <CR> (0x0D); for a Linux/Unix OS, <enter> is represented as <LF> (0x0A).

**Prefix / Suffix / Preamble / Postamble string setting:**

They are appended to the data automatically when a barcode is decoded.

Example: Add a symbol of "\$" as a prefix for all symbols.

Steps:

- 1) Scan **SETUP** and **Prefix string setting** barcode.
- 2) Use the ASCII table to find the value of \$→24.
- 3) Scan **2** and **4** from the barcode on the foldout back page.
- 4) Scan **END** barcode.

Scanning steps: Scan the following barcodes in order.

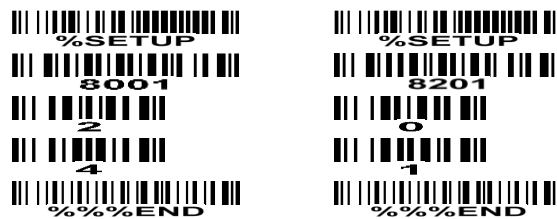

**Insert G1/G2/G3/G4 string setting:** The scanner offers 4 positions and 4 character strings to insert among the symbol.

Example: Set G1 string to be "AB".

Original code data	"1 2 3 4 5 6"
Output code data	"1 2 A B 3 4 5 6"

Steps:

- 1) Scan **SETUP** and **Insert G1 string setting** barcode "8005".
- 2) Use the ASCII table to find the value of A→41, B→42.
- 3) Scan **4**, **1** and **4**, **2** from the barcode on the foldout back page.
- 4) Scan **END** barcode.
- 5) Refer to [3-34 G1-G4 string position & Code ID position](#).
- 6) Refer to [3-9 Hand-held scan & some global settings](#).

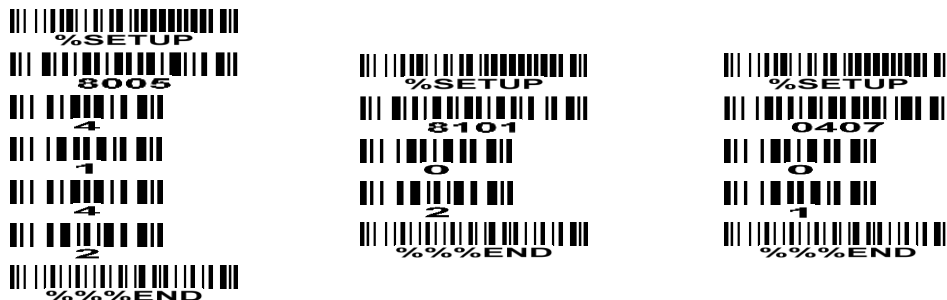

Testing barcode:



**FN1 substitution string setting:** The FN1 character (0x1D) in an UCC/EAN128 barcode, or a Code 128 barcode, or a GS1 DataBar barcode can be substituted with a defined string.

**Single character C1/C2 replacement:** By setting, a defined character in the data string can be replaced by another defined character. The C1 and C2 replacement are applied simultaneously.

Example: Replace all the “A” character in a data string to be “B” character.

Original code data	“1 2 3 A 5 A”
Output code data	“1 2 3 B 5 B”

Steps: scan the following barcodes in order. The ASCII value for “A” is 41, and the ASCII value for “B” is 42.

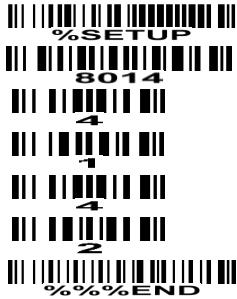

Testing barcode:

















**%SETUP** SETUP

Option bar code	Option	Alpha. entry	Single-scan setting
Prefix string setting  <b>8001</b>	0-22 characters	00-FF <sub>16</sub>	
	None	00*	 %8001H00%
Suffix string setting  <b>8002</b>	0-22 characters	00-FF <sub>16</sub>	
	<ENTER>	0D0A*	
Preamble string setting  <b>8003</b>	0-22 characters	00-FF <sub>16</sub>	
	None	00*	 %8003H00%
Postamble string setting  <b>8004</b>	0-22 characters	00-FF <sub>16</sub>	
	None	00*	 %8004H00%
Insert G1 string setting  <b>8005</b>	0-22 characters	00-FF <sub>16</sub>	
	None	00*	 %8005H00%
Insert G2 string setting  <b>8006</b>	0-22 characters	00-FF <sub>16</sub>	
	None	00*	 %8006H00%
Insert G3 string setting  <b>8007</b>	0-22 characters	00-FF <sub>16</sub>	
	None	00*	 %8007H00%
Insert G4 string setting  <b>8008</b>	0-22 characters	00-FF <sub>16</sub>	
	None	00*	 %8008H00%
FN1 substitution string setting  <b>8009</b>	0-4 characters	00-FF <sub>16</sub>	
	<SP>	20*	 %8009H20%
Truncate leading G5 string setting	A un-defined character	00	 %8010H00%



**%SETUP** SETUP

Option bar code	Option	Alpha. entry	Single-scan setting
 <b>8010</b>	1-22 defined characters	01-7F <sub>16</sub>	
	<0>	30*	 %8010H30%
Repeat of a G5 character setting  <b>8011</b>	Once	01*	 %8011H01%
	Defined times	01-22	
	Un-defined times (All)	FF	 %8011HFF%
Truncate ending G4 string setting  <b>8012</b>	A un-defined character	00	 %8012H00%
	1-22 defined characters	01-7F <sub>16</sub>	
	<0>	30*	 %8012H30%
Repeat of a G4 character setting  <b>8013</b>	Once	01*	 %8013H01%
	Defined times	01-22	
	Un-defined times (All)	FF	 %8013HFF%
Single character C1 replacement  <b>8014</b>	0000-FFFF <sub>16</sub>	0000*	
		0000-FFFF <sub>16</sub>	
Single character C2 replacement  <b>8015</b>	0000-FFFF <sub>16</sub>	0000*	
		0000-FFFF <sub>16</sub>	



**%%%**END END

### 3-34 G1-G4 string position & Code ID position

Format of barcode data transmission:

Prefix	Code name	Preamble	Code ID	Code length	Code data	Code ID	Postamble	Suffix
--------	-----------	----------	---------	-------------	-----------	---------	-----------	--------

**Insert G1/G2/G3/G4 string position:** The scanner offers 4 positions to insert strings among the symbol. In case of the insertion position is greater than the length of the symbol, the insertion of string is not effective.

**Code ID position:** It is allowed to select different positions of code ID placement.



**%SETUP** SETUP

Option bar code	Option	Alpha. entry	Single-scan setting
Insert G1 string position  <b>8101</b>	00-99	00-99	
		00*	 %8101D00%
Insert G2 string position  <b>8102</b>	00-99	00-99	
		00*	 %8102D00%
Insert G3 string position  <b>8103</b>	00-99	00-99	
		00*	 %8103D00%
Insert G4 string position  <b>8104</b>	00-99	00-99	
		00*	 %8104D00%
Code ID position  <b>8105</b>	Before code data	00*	 %8105D00%
	After code data	01	 %8105D01%



**%%%**END END

### 3-35 String transmission

*Note: The information in this chapter is closely related to the chapter of String setting.*

**Format of barcode data transmission:**

Prefix	Code name	Preamble	Code ID	Code length	Code data	Code ID	Postamble	Suffix
--------	-----------	----------	---------	-------------	-----------	---------	-----------	--------

**Prefix transmission:** By setting Enable, prefix will be appended before the data transmitted.

**Suffix transmission:** By setting Enable, suffix will be appended after the data is transmitted.

**Code name transmission:** By setting Enable, code name will be transmitted before code data.

**Preamble transmission:** By setting Enable, preamble will be appended before the data transmitted.

**Postamble transmission:** By setting Enable, postamble will be appended after the data is transmitted.

**Code ID transmission:** Code ID can be transmitted in the format of either Proprietary ID or AIM ID.

Refer to [1-2 Default setting for each barcode](#).

**Code length transmission:** The length of code data string can be transmitted before the code data when Enable is selected. The length is represented by a number with two digits.

**Case conversion:** The characters within code data or the whole output string can be set in either upper case or lower case.

**FN1 substitution transmission:** The scanner supports a FN1 substitution feature. The replacement string of FN1 can be chosen by user (see [3-33 G1-G4 & FN1 substitution string setting](#)).

**All-non-printable-character string transmission with string setting:** By setting enable, all string settings, e.g.  Preamble transmission or  Insert G1 string setting, are active for an all-non-printable-character string.





Here a non-printable character means a character with ASCII value between 0x00 to 0x1F.

**Transmit the first N data characters only:** The scanner supports to only transmit the first N data characters of a barcode. The number of N can be set as a digit between 1 and 99.

**Transmit the last N data characters only:** The scanner supports to only transmit the last N data characters of a barcode. The number of N can be set as a digit between 1 and 99.



**%SETUP** SETUP

Option bar code	Option	Alpha. entry	Single-scan setting
Prefix transmission  <b>8201</b>	Disable	00*	 %8201D00%
	Enable	01	 %8201D01%
Suffix transmission  <b>8202</b>	Disable	00	 %8202D00%
	Enable	01*	 %8202D01%
Code name transmission  <b>8203</b>	Disable	00*	 %8203D00%
	Enable	01	 %8203D01%
Preamble transmission  <b>8204</b>	Disable	00*	 %8204D00%
	Enable	01	 %8204D01%
Postamble transmission  <b>8205</b>	Disable	00*	 %8205D00%
	Enable	01	 %8205D01%
Code ID transmission  <b>8206</b>	Disable	00*	 %8206D00%
	Proprietary ID	01	 %8206D01%
	AIM ID	02	 %8206D02%
Code length transmission  <b>8207</b>	Disable	00*	 %8207D00%
	Enable	01	 %8207D01%
Case conversion  <b>8208</b>	Disable	00*	 %8208D00%
	Upper (data only)	01	 %8208D01%
	Lower (data only)	02	 %8208D02%
	Upper (whole string)	03	 %8208D03%



**%SETUP** SETUP

Option bar code	Option	Alpha. entry	Single-scan setting
	Lower (whole string)	04	 %8208D04%
FN1 substitution transmission  <b>8209</b>	Disable	00*	 %8209D00%
	Keyboard wedge/USB	01	 %8209D01%
	RS-232	02	 %8209D02%
	Keyboard wedge/ USB/RS-232	03	 %8209D03%
All-non-printable-character string transmission with string setting  <b>8210</b>	Disable	00*	 %8210D00%
	Enable	01	 %8210D01%
Transmit the first N data characters only  <b>8211</b>	All	99*	 %8211D99%
	01-99	01-99	
Transmit the last N data characters only  <b>8212</b>	All	99*	 %8212D99%
	01-99	01-99	



**%%%**END END



## 4 Troubleshooting

NO.	Problem	Possible causes	Possible solutions
1	Nothing happens when you follow the operating instructions, or the scanner displays erratic behavior.	No power to the scanner.	Check the system power. Ensure the power supply is connected.
		Incorrect cables.	Use the original cables.
		Connections are loose.	Check for loose cable connections.
2	Laser comes on, but the scanner does not decode.	Bar code symbol is unreadable.	Check the symbol to make sure it is not defaced. Try scanning test symbols of the same bar code type.
		Scanner is not programmed for the correct bar code type.	Be sure the scanner is programmed to read the type of bar code you are scanning.
		Distance between scanner and bar code is incorrect.	Move the scanner closer to or further from the bar code.
3	Scanned data is incorrectly displayed on the host.	Scanner is not programmed to work with the host. Check scanner host type parameters or editing options.	Be sure proper host is selected. For RS-232, ensure the scanner's communication parameters match the host's settings.
4	Other circumstances.	/	Contact your distributor or the manufactory support centre.

## 5 Maintenance

Cleaning the exit window is the only maintenance required. A dirty window may affect scanning accuracy.

1. Do not allow any abrasive material to touch the window.
2. Remove any dirt particles with a damp cloth.
3. Wipe the window using a tissue moistened with water.
4. Do not spray water or other cleaning liquids directly into the window.
5. Use a piece of soft and dry cloth when cleaning the scanner.

## 6 ASCII table

		for keyboard wedge		for RS-232	
L \ H	0	1	0	1	
	0	Null		NUL	DLE
1	Up	F1	SOH	DC1	
2	Down	F2	STX	DC2	
3	Left	F3	ETX	DC3	
4	Right	F4	EOT	DC4	
5	PgUp	F5	ENQ	NAK	
6	PgDn	F6	ACK	SYN	
7		F7	BEL	ETB	
8	Bs	F8	BS	CAN	
9	Tab	F9	HT	EM	
A		F10	LF	SUB	
B	Home	Esc	VT	ESC	
C	End	F11	FF	FS	
D	Enter	F12	CR	GS	
E	Insert	Ctrl+	SO	RS	
F	Delete	Alt+	SI	US	

Notes: The 2nd and the 3rd columns above are used for keyboard wedge only.

L \ H	2	3	4	5	6	7
	0	SP	0	@	P	`
1	!	1	A	Q	a	q
2	“	2	B	R	b	r
3	#	3	C	S	c	s
4	\$	4	D	T	d	t
5	%	5	E	U	e	u
6	&	6	F	V	f	v
7	‘	7	G	W	g	w
8	(	8	H	X	h	x
9	)	9	I	Y	i	y
A	*	:	J	Z	j	z
B	+	;	K	[	k	{
C	,	<	L	\	l	
D	-	=	M	]	m	}
E	.	>	N	^	n	~
F	/	?	O	_	o	DEL

Example: ASCII “A” = “41”.

## 7 Barcode representing non-printable character

Notes to make the following barcode:

1. According to different barcode printing software, the method of printing following barcode is different.
2. If using CODESOFT software, firstly read the information through “Help→Index→Code128→Special input syntax”. Also refer to ASCII table. For example, if we wish to make “F1” barcode, select “Code128”, then select “CODE A” type, and input “{DC1}” as data.



**Up** ↑



**Down** ↓



**Left** ←



**Right** →



**Page Up**



**Page Down**



**Backspace**



**Tab**



**Home**



**End**



**Enter**



**Insert**



**Delete**



**F1**



**F2**



**F3**



**F4**



**F5**



**F6**



**F7**



**F8**



**F9**



**F10**



**Esc**



**F11**



**F12**

## 8 Quick setting to point or distributed coordination wireless network





The steps of setting are:

- Both the handheld unit and the cradle are in normal working mode. Normally it means that only the blue LED on the handheld unit and only the blue LED on the cradle are ON as shown below.



The scanner offers two kinds of wireless network topology: point coordination and distributed coordination. Note that the current applied wireless network topology of the handheld unit or the cradle does NOT make any difference in the following setting.

- Scan **ONE** of the following setting barcodes. Other radio parameters include channel no., address, etc.

Barcode	Description
 <b>%2PNET</b>	Set to point coordination network without changing other radio parameters
 <b>%2DNET</b>	Set to distributed coordination network without changing other radio parameters
 <b>2PNET+</b>	Set to point coordination network with returning default radio parameters
 <b>2DNET+</b>	Set to distributed coordination network with returning default radio parameters

- The blue LED on the handheld unit will blink and the beeper will beep regularly to indicate that the handheld unit is ready to be positioned onto the cradle.

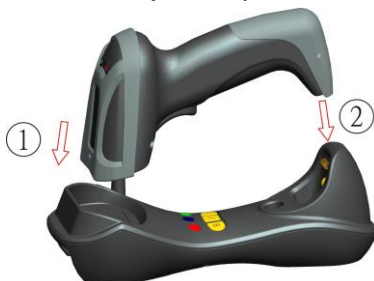



- Firmly position the handheld unit onto the cradle within 15 seconds. A long beep and a short beep will be emitted to indicate a successful setting; otherwise, three short beeps will be emitted to indicate an unsuccessful setting.

Referring to [11 Display firmware version & radio communication setting](#), check the current radio communication setting of the handheld unit and the cradle.

# 9 Test Chart

UPC-A  
  
6 59871 23231 9

UPC-E  
  
0 232310 7

UPC-E1  
  
1 6 5 4 3 2 1 1

EAN-13  
  
1 234567 891019

ISBN/ISSN  
  
9 780194 315104

EAN-8  
  
0123 4510

Code 39  
  
\*0189-.\$AZ\*

Code 32  
  
A908765439

Trioptic Code 39  
(Default setting: Disable)  
  
\$123456\$

Interleaved 2 of 5  
  
0123456789

Industrial 2 of 5  
(Default setting: Disable)  
  
0123456789

Matrix 2 of 5  
  
9876543210

Codabar  
  
a01+-.:\$89a

Test chart (continue)

Code 128



01AZ[+~\*]/za98

UCC/EAN 128



01AZ[]+~\*az54

ISBT 128



=1234 56789

Code 93



01AZ+~/\*az89

Code 11

(Default setting: Disable)



123456789-0

MSI/Plessey

(Default setting: Disable)



0123456789

UK/Plessey



01ABEF89

China Post



54789632145

Telepen



\_1234567z

GS1 DataBar (GS1 DataBar Truncated)



(01) 12345678901231

GS1 DataBar Limited



(01) 1 2345678 90126 2

GS1 DataBar Expanded



Ab\_09+yZ

## 10 Return default parameters



**%%ADEF**

All parameters of handheld unit return to default setting

**WARNING:** If you wish to return all parameters of the handheld unit, including radio communication setting, to default setting, please scan the barcode above.



**%%BADEF**

All parameters of cradle return to default setting ✖

**WARNING:** If you wish to return all parameters of the cradle, including radio communication setting, to default setting, please scan the barcode above.



**%%%DEF**

Some parameters of handheld unit return to default setting

**WARNING:** If you wish to return all parameters of the handheld unit, excluding radio communication setting, to default setting, please scan the barcode above.



**%%BDEF**

Some parameters of cradle return default value initialization ✖

**WARNING:** If you wish to return all parameters of the cradle, excluding radio communication setting, to default setting, please scan the barcode above.

Note: The settings indicated with (✖) are valid only when the cradle is in **upgrade ready mode**.

### Cradle entering upgrade ready mode

Keep pressing the  button on the cradle, until the blue LED is flashing. Then three LEDs will all be turned ON, this indicates the cradle being upgrade ready mode.



## 11 Display firmware version & radio communication setting



**%%BVER**

### Cradle firmware version display

If you wish to display the firmware version of the cradle, please scan the barcode above.



**%%%VER**

### Handheld unit firmware version display

If you wish to display the firmware version of the handheld unit, please scan the barcode above.



**%%BSCI**

### Cradle radio communication setting display※

If you wish to display the radio communication setting of the cradle, please scan the barcode above.



**%%%SCI**

### Handheld unit radio communication setting display※

If you wish to display the radio communication setting of the handheld unit, please scan the barcode above.

Note: The settings indicated with (※) are valid only when the cradle is in **upgrade ready mode**.

### Cradle entering upgrade ready mode

Keep pressing the  button on the cradle, until the blue LED is flashing. Then three LEDs will all be turned ON, this indicates the cradle being upgrade ready mode.

## 12 Configuration alphanumeric entry barcode



To finish parameter setting, please scan the bar code below.

